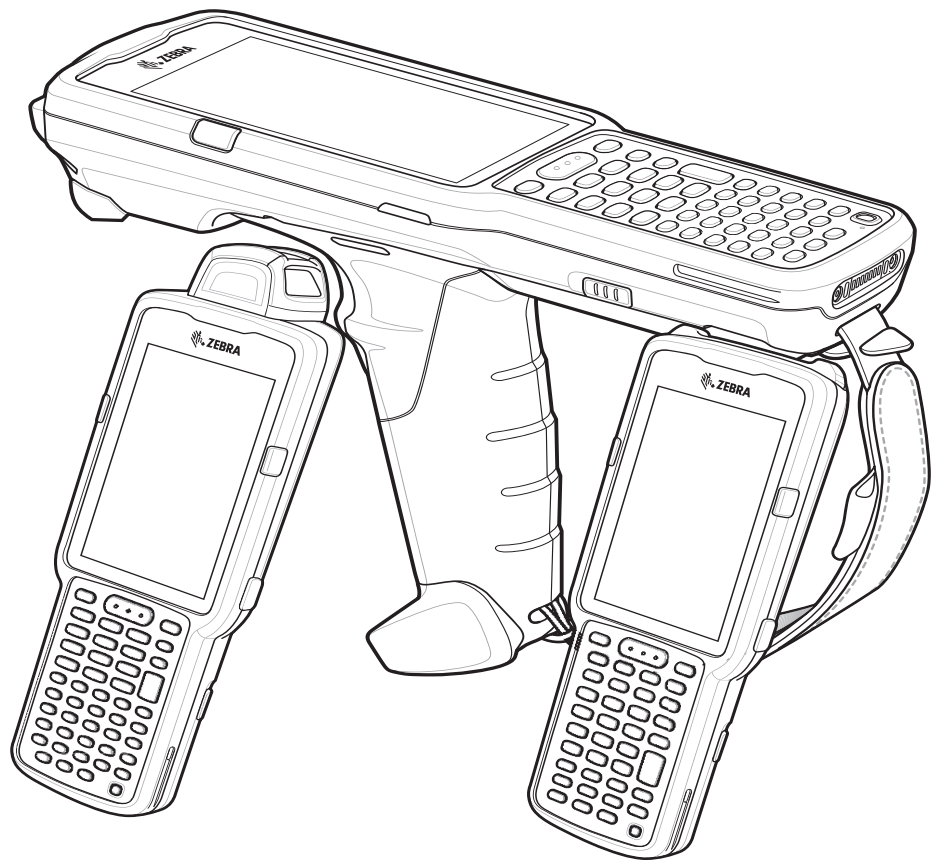


# MC33XX

## Mobile Computer



## Integrator Guide for Android™ 7.1.2 Nougat



**ZEBRA**

---

## Copyright

© 2018 ZIH Corp. and/or its affiliates. All rights reserved. ZEBRA and the stylized Zebra head are trademarks of ZIH Corp., registered in many jurisdictions worldwide. Google, Android, Google Play and other marks are trademarks of Google LLC. All other trademarks are the property of their respective owners.

COPYRIGHTS & TRADEMARKS: For complete copyright and trademark information, go to [www.zebra.com/copyright](http://www.zebra.com/copyright).

WARRANTY: For complete warranty information, go to [www.zebra.com/warranty](http://www.zebra.com/warranty).

END USER LICENSE AGREEMENT: For complete EULA information, go to [www.zebra.com/eula](http://www.zebra.com/eula).

---

## Terms of Use

- Proprietary Statement

This manual contains proprietary information of Zebra Technologies Corporation and its subsidiaries ("Zebra Technologies"). It is intended solely for the information and use of parties operating and maintaining the equipment described herein. Such proprietary information may not be used, reproduced, or disclosed to any other parties for any other purpose without the express, written permission of Zebra Technologies.

- Product Improvements

Continuous improvement of products is a policy of Zebra Technologies. All specifications and designs are subject to change without notice.

- Liability Disclaimer

Zebra Technologies takes steps to ensure that its published Engineering specifications and manuals are correct; however, errors do occur. Zebra Technologies reserves the right to correct any such errors and disclaims liability resulting therefrom.

- Limitation of Liability

In no event shall Zebra Technologies or anyone else involved in the creation, production, or delivery of the accompanying product (including hardware and software) be liable for any damages whatsoever (including, without limitation, consequential damages including loss of business profits, business interruption, or loss of business information) arising out of the use of, the results of use of, or inability to use such product, even if Zebra Technologies has been advised of the possibility of such damages. Some jurisdictions do not allow the exclusion or limitation of incidental or consequential damages, so the above limitation or exclusion may not apply to you.

---

## Revision History

Changes to the original guide are listed below:

Change	Date	Description
-01 Rev A	12/2017	Initial release.
-02 Rev A	03/2018	Update to include MC33XX-R and MC33XX-S Configurations.

Change	Date	Description
-03 Rev A	04/2018	Remove Decode Haptic Feedback from Scan Params in the DataWedge Configuration chapter.
-04 Rev A	07/2018	Add note in Maintenance and Troubleshooting. SmartMU section only applies to LifeGuard 8 or earlier.

# Table of Contents

Copyright .....	2
Terms of Use .....	2
Revision History .....	2
<b>About This Guide</b>	
Introduction .....	13
Configurations .....	13
Software Versions .....	16
Chapter Descriptions .....	16
Notational Conventions .....	16
Icon Conventions .....	17
Related Documents and Software .....	17
Service Information .....	18
Provide Documentation Feedback .....	18
<b>Getting Started</b>	
Introduction .....	19
Setup .....	19
Installing a microSD Card .....	19
Installing the MC33XX-G Battery .....	21
Installing the MC33XX-R/S Battery .....	22
Charging the Battery .....	23
Backup Power .....	25
Charging Temperature .....	25
Charging Spare Batteries .....	25
Hot Swap Mode .....	25
Google Account Setup .....	25
Resetting the Device .....	26
Performing a Soft Reset .....	26
Performing a Hard Reset .....	26
<b>Accessories</b>	
Introduction .....	27
MC33XX Accessories .....	27
Compatibility .....	32

## Table of Contents

Battery Comparison .....	32
Battery Compatibility .....	32
1-Slot USB Charge Cradle .....	34
Charging the MC33XX Battery .....	34
Charging an MC33XX Spare Battery .....	35
Battery Charging in 1- Slot USB Charge Cradle .....	36
Charging Temperature .....	37
5-Slot Charge Only ShareCradle .....	38
Charging the MC33XX Battery .....	38
Battery Charging in the 5-Slot Charge Only ShareCradle .....	39
Charging Temperature .....	39
5-Slot Ethernet ShareCradle .....	40
Charging the MC33XX Battery .....	40
Battery Charging in the 5-Slot Ethernet ShareCradle .....	41
Charging Temperature .....	41
Daisy-chaining Ethernet ShareCradles .....	41
Ethernet Settings .....	42
Configuring Ethernet Proxy Settings .....	42
Configuring Ethernet Static IP Address .....	43
Establishing Ethernet Connection .....	44
LED Indicators .....	45
5-Slot ShareCradle with 4-Slot Battery Charger .....	46
Charging the MC33XX Battery .....	46
Charging Spare Batteries .....	47
Battery Charging in the 5-Slot ShareCradle with 4-Slot Battery Charger .....	47
Charging Temperature .....	47
5-Slot Ethernet ShareCradle with 4-Slot Battery Charger .....	48
Charging the MC33XX Battery .....	48
Charging Spare Batteries .....	49
Battery Charging in the 5-Slot Ethernet ShareCradle with 4-Slot Battery Charger .....	49
Charging Temperature .....	49
Daisy-chaining Ethernet Cradles .....	49
Ethernet Settings .....	50
Configuring Ethernet Proxy Settings .....	50
Configuring Ethernet Static IP Address .....	51
Establishing Ethernet Connection .....	52
LED Indicators .....	53
4-Slot Spare Battery Charger .....	53
Charging Spare Batteries .....	53
Battery Charging .....	54
Spare Battery Charging .....	54
Charging Temperature .....	55
20-Slot Spare Battery Charger .....	55
Charging Spare Batteries .....	55
Battery Charging .....	56
Spare Battery Charging .....	56
Charging Temperature .....	57
USB Charge Cable .....	58
Connecting the USB Charge Cable to Device .....	58
Connecting the USB Charge Cable to Host Computer .....	59
Main Battery Charging .....	59

## Table of Contents

Charging the Device .....	60
Main Battery Charging .....	60
Disconnecting the USB Charge Cable .....	61
MC33XX Charge Only Adapter .....	62
Adapter Installation .....	62
Charging Temperature .....	64
MC33XX-G Rubber Boot .....	65
MC33XX-R Rubber Boot .....	66
MC33XX-S Rubber Boot .....	68
Rigid Holster .....	69
MC33XX-G Fabric Holster .....	71
Belt Strap .....	71
Shoulder Strap .....	71
Using the Belt Strap .....	72
Using the Shoulder Strap .....	73
MC33XX-R/S Fabric Holster .....	75
Belt Clip .....	75
Shoulder Strap .....	75
Using the Belt Clip .....	76
Using the Shoulder Strap .....	78
Un-powered Forklift Mount .....	80
Installation .....	80
Replacement Hand Strap for MC33XX-G .....	82
Replacement Hand Strap for MC33XX-R/S .....	84
Lanyard .....	86
Install Lanyard on MC33XX .....	86
Using the Cross-body Strap .....	87
Using the Belt Clip .....	88
Charging the MC33XX with the Lanyard .....	89
<b>USB Communication</b>	
Introduction .....	90
Connecting to a Host Computer via USB .....	90
Transferring Files using Media Transfer Protocol .....	90
Transferring Files using Photo Transfer Protocol .....	91
Disconnect from the Host Computer .....	92
<b>Datawedge Configuration</b>	
Introduction .....	93
Basic Scanning .....	93
Barcode Capture with Imager .....	93
Barcode Capture with Laser Scanner .....	94
Profiles .....	95
Profile0 .....	95
Plug-ins .....	96
Input Plug-ins .....	96
Process Plug-ins .....	96
Output Plug-ins .....	96
Profiles Screen .....	96

## Table of Contents

Profile Context Menu .....	97
Options Menu .....	98
Disabling DataWedge .....	98
Creating a New Profile .....	98
Profile Configuration .....	99
Associating Applications .....	99
Data Capture Plus .....	102
Barcode Input .....	105
Enabled .....	105
Scanner Selection .....	105
Decoders .....	106
Decoder Params .....	107
Codabar .....	108
Code 11 .....	108
Code128 .....	108
Code39 .....	109
Code93 .....	110
Composite AB .....	110
Discrete 2 of 5 .....	110
GS1 DataBar Limited .....	110
HAN XIN .....	111
Interleaved 2 of 5 .....	111
Matrix 2 of 5 .....	111
MSI .....	112
Trioptic 39 .....	112
UK Postal .....	112
UPCA .....	112
UPCE0 .....	112
UPCE1 .....	113
US Planet .....	113
Decode Lengths .....	113
UPC EAN Params .....	113
Reader Params .....	116
Scan Params .....	118
UDI Params .....	119
Keep enabled on suspend .....	119
Simulscan Input .....	119
Keystroke Output .....	120
Intent Output .....	122
Intent Overview .....	122
IP Output .....	123
Usage .....	124
Using IP Output with IPWedge .....	125
Using IP Output without IPWedge .....	126
Generating Advanced Data Formatting Rules .....	127
Configuring ADF Plug-in .....	127
Creating a Rule .....	128
Defining a Rule .....	128
Defining Criteria .....	129
Defining an Action .....	131
Deleting a Rule .....	131

## Table of Contents

Order Rules List .....	132
Deleting an Action .....	133
ADF Example .....	133
DataWedge Settings .....	136
Importing a Configuration File .....	137
Exporting a Configuration File .....	138
Importing a Profile File .....	138
Exporting a Profile .....	138
Restoring DataWedge .....	138
Configuration and Profile File Management .....	139
Enterprise Folder .....	139
Auto Import .....	139
Programming Notes .....	139
Overriding Trigger Key in an Application .....	139
Capture Data and Taking a Photo in the Same Application .....	139
Disable DataWedge on Device and Mass Deploy .....	140
DataWedge APIs .....	140
Reporting .....	140
Soft Scan Feature .....	140
Sample .....	141
Scanner Input Plugin .....	141
Function Prototype .....	141
Parameters .....	141
Return Values .....	141
Example .....	142
Comments .....	142
Enumerate Scanners .....	142
Function Prototype .....	142
Parameters .....	142
Return Values .....	143
Example .....	143
Comments .....	144
Set Default Profile .....	144
Default Profile Recap .....	144
Usage Scenario .....	144
Function Prototype .....	144
Parameters .....	144
Return Values .....	144
Example .....	145
Comments .....	145
Reset Default Profile .....	146
Function Prototype .....	146
Parameters .....	146
Return Values .....	146
Example .....	146
Comments .....	146
Switch To Profile .....	147
Profiles Recap .....	147
Usage Scenario .....	147
Function Prototype .....	147
Parameters .....	147



## Table of Contents

Return Values .....	148
Example .....	148
Comments .....	148
Notes .....	149
Imager as Camera .....	149
<b>Settings</b>	
Introduction .....	151
WLAN Configuration .....	151
Configuring a Wi-Fi Network .....	151
Manually Adding a Wi-Fi Network .....	152
Configuring for a Proxy Server .....	153
Configuring the Device to Use a Static IP Address .....	154
Advanced Wi-Fi Settings .....	155
Additional Wi-Fi Settings .....	156
Screen Unlock Settings .....	158
Set Screen Unlock Using PIN .....	159
Set Screen Unlock Using Password .....	160
Set Screen Unlock Using Pattern .....	160
Passwords .....	161
Button Remapping .....	161
Remapping a Button .....	162
Accounts .....	163
Language Usage .....	163
Changing the Language Setting .....	163
Adding Words to the Dictionary .....	163
Keyboard Settings .....	164
PTT Express Configuration .....	164
RxLogger .....	164
RxLogger Configuration .....	165
ANR Module .....	166
Kernal Module .....	166
Logcat Module .....	167
LTS Module .....	168
Ramoops Module .....	168
Resource Module .....	168
Snapshot Module .....	169
TCPDump Module .....	170
Tombstone Module .....	170
Configuration File .....	170
Enabling Logging .....	170
Disabling Logging .....	170
Extracting Log Files .....	170
RxLogger Utility .....	171
App View .....	171
Viewing Logs .....	171
Backup .....	172
Archiving .....	173
Overlay View .....	173
Removing the Main Chat Head .....	173

## Table of Contents

Viewing Logs .....	173
Removing a Sub Chat Head Icon .....	175
Backup .....	175
About Phone .....	176
.....	176
<b>Application Deployment</b>	
Introduction .....	177
Security .....	177
Secure Certificates .....	177
Installing a Secure Certificate .....	177
Configuring Credential Storage Settings .....	178
License Manager .....	179
Android Versions Supported .....	179
Requirements .....	179
Start Application .....	179
Active License Display .....	180
Activate License .....	181
Add License Source .....	183
Refresh a License .....	184
Settings .....	184
Notifications Settings .....	185
License Sources Settings .....	186
Add License Source in Settings 186	
About Settings .....	187
Development Tools .....	189
Android .....	189
EMDK for Android .....	190
StageNow .....	190
ADB USB Setup .....	190
Enabling USB Debugging .....	190
Application Installation .....	191
Installing Applications Using the USB Connection .....	191
Installing Applications Using the Android Debug Bridge .....	193
Installing Applications Using a microSD Card .....	194
Uninstalling an Application .....	194
Performing a System Update .....	195
Download the System Update Package .....	195
Using microSD Card .....	195
Using ADB .....	197
Verify System Update Installation .....	197
Performing an Enterprise Reset .....	198
Download the Enterprise Reset Package .....	198
Using microSD Card .....	198
Using ADB .....	198
Performing a Factory Reset .....	199
Download the Factory Reset Package .....	199
Using microSD Card .....	199
Using ADB .....	200
Storage .....	201

## Table of Contents

Random Access Memory .....	201
Internal Storage .....	202
External Storage .....	204
Formatting a microSD Card .....	206
Format as Internal Memory .....	208
Enterprise Folder .....	210
Application Management .....	210
Viewing Application Details .....	211
Managing Downloads .....	212
.....	212
<b>Maintenance and Troubleshooting</b>	
Introduction .....	213
Maintaining the MC33XX .....	213
Battery Safety Guidelines .....	214
Cleaning Instructions .....	214
Approved Cleanser Active Ingredients .....	215
Harmful Ingredients .....	215
Cleaning Instructions .....	215
Special Cleaning Notes .....	215
Cleaning Materials Required .....	215
Cleaning Frequency .....	215
Cleaning the MC33XX .....	215
Housing .....	215
Display .....	216
Exit Window .....	216
Connector Cleaning .....	216
Cleaning Cradle Connectors .....	216
Troubleshooting SmartMU .....	217
Camera Preview .....	217
Home Screen .....	218
Status 218	
Connected IP Network 218	
Device Information 219	
Scan List .....	219
Filter Options 220	
Detailed Capabilities for BSSID 220	
Device Coverage View .....	221
Auto Reachability Test 222	
Networking Tools .....	222
Ping 222	
Ping Settings 223	
Fusion Advanced Configuration 224	
About 225	
Troubleshooting .....	226
Troubleshooting the MC33XX .....	226
1-Slot USB Charge Cradle Troubleshooting .....	227
5-Slot Charge Only ShareCradle Troubleshooting .....	229
5-Slot Ethernet ShareCradle Troubleshooting .....	229

## Table of Contents

5-Slot ShareCradle with 4-Slot Battery Charger Troubleshooting .....	230
5-Slot Ethernet ShareCradle with 4-Slot Battery Charger Troubleshooting .....	231
4-Slot Spare Battery Charger Troubleshooting .....	231
20-Slot Spare Battery Charger Troubleshooting .....	232
USB Charge Cable .....	232
<b>Technical Specifications</b>	
Introduction .....	234
MC33XX Technical Specifications .....	234
SE965 Decode Zone .....	238
SE4750-SR Decode Zone .....	239
SE4850-ER Decode Zone .....	240
MC33XX Accessory Specifications .....	241
1-Slot USB Charge Cradle with Spare Battery Charger Technical Specifications .....	242
5-Slot Charge Only ShareCradle Technical Specifications .....	242
5-Slot Ethernet ShareCradle Technical Specifications .....	243
5-Slot Charge ShareCradle with 4-Slot Battery Charger Technical Specifications .....	243
5-Slot Ethernet ShareCradle with 4-Slot Battery Charger Technical Specifications .....	244
4-Slot Spare Battery Charger Technical Specifications .....	245
20-Slot Spare Battery Charger Technical Specifications .....	245
USB Charge Cable Technical Specifications .....	246
<b>Keypad Remap Strings</b>	
Keypad Remap Strings .....	247

# About This Guide

---

## Introduction

This guide provides information about using the MC33XX mobile computers and accessories.

✓ **NOTE:** Screens and windows pictured in this guide are samples and can differ from actual screens.

---

## Configurations

MC33XX used in this guide refers to all configurations, except where noted. MC33XX-G refers to the Trigger configuration. MC33XX-R refers to the Rotate configuration. MC33XX-S refers to the Straight configuration. MC33XX-S45 refers to the 45 degree angle Straight configuration.

This guide covers the following configurations:

**Table 1** Configurations

Configuration	Radios	Display	Memory	Data Capture Options	Operating System
MC33XX-G Standard	WLAN: IEEE® 802.11a/b/g/n/ac/d /h/i/k/r/w  WPAN: Bluetooth V4.1, V2.1 + EDR w/ Bluetooth Low Energy (BLE)	4.0" color	2 GB RAM / 16 GB Flash	SE965 1D, SE4750-SR 2D	Android-based AOSP/GMS 7.1.2
MC33XX-G Premium	WLAN: IEEE® 802.11a/b/g/n/ac/d /h/i/k/r/w  WPAN: Bluetooth V4.1, V2.1 + EDR w/ Bluetooth Low Energy (BLE)  NFC	4.0" color	4 GB RAM / 16 GB Flash	SE965 1D, SE4750-SR 2D, SE4850-ER 2D	Android-based AOSP/GMS 7.1.2

**Table 1** Configurations (Continued)



Configuration	Radios	Display	Memory	Data Capture Options	Operating System
MC33XX–G Premium +	WLAN: IEEE® 802.11a/b/g/n/ac/d /h/i/k/r/w  WPAN: Bluetooth V4.1, V2.1 + EDR w/ Bluetooth Low Energy (BLE)  NFC	4.0" color	4 GB RAM / 32 GB Flash	SE965 1D, SE4750-SR 2D, SE4850-ER 2D	Android-based AOSP/GMS 7.1.2
MC33XX–R Standard	WLAN: IEEE® 802.11a/b/g/n/ac/d /h/i/k/r/w  WPAN: Bluetooth V4.1, V2.1 + EDR w/ Bluetooth Low Energy (BLE)	4.0" color	2 GB RAM / 16 GB Flash	SE965 1D	Android-based AOSP/GMS 7.1.2
MC33XX–R Premium	WLAN: IEEE® 802.11a/b/g/n/ac/d /h/i/k/r/w  WPAN: Bluetooth V4.1, V2.1 + EDR w/ Bluetooth Low Energy (BLE)  NFC	4.0" color	4 GB RAM / 16 GB Flash	SE965 1D	Android-based AOSP/GMS 7.1.2
MC33XX–R Premium +	WLAN: IEEE® 802.11a/b/g/n/ac/d /h/i/k/r/w  WPAN: Bluetooth V4.1, V2.1 + EDR w/ Bluetooth Low Energy (BLE)  NFC	4.0" color	4 GB RAM / 32 GB Flash	SE965 1D	Android-based AOSP/GMS 7.1.2
MC33XX–S Standard	WLAN: IEEE® 802.11a/b/g/n/ac/d /h/i/k/r/w  WPAN: Bluetooth V4.1, V2.1 + EDR w/ Bluetooth Low Energy (BLE)	4.0" color	2 GB RAM / 16 GB Flash	SE965 1D, SE4750-SR 2D, SE4850-ER 2D	Android-based AOSP/GMS 7.1.2



**Table 1** Configurations (Continued)

Configuration	Radios	Display	Memory	Data Capture Options	Operating System
MC33XX-S Premium	WLAN: IEEE® 802.11a/b/g/n/ac/d /h/i/k/r/w  WPAN: Bluetooth V4.1, V2.1 + EDR w/ Bluetooth Low Energy (BLE)  NFC	4.0" color	4 GB RAM / 16 GB Flash	SE965 1D, SE4750-SR 2D, SE4850-ER 2D	Android-based AOSP/GMS 7.1.2
MC33XX-S Premium +	WLAN: IEEE® 802.11a/b/g/n/ac/d /h/i/k/r/w  WPAN: Bluetooth V4.1, V2.1 + EDR w/ Bluetooth Low Energy (BLE)  NFC	4.0" color	4 GB RAM / 32 GB Flash	SE4750-SR 2D, SE4850-ER 2D	Android-based AOSP/GMS 7.1.2
MC33XX-S45 Standard	WLAN: IEEE® 802.11a/b/g/n/ac/d /h/i/k/r/w  WPAN: Bluetooth V4.1, V2.1 + EDR w/ Bluetooth Low Energy (BLE)	4.0" color	2 GB RAM / 16 GB Flash	SE4750-SR 2D	Android-based AOSP/GMS 7.1.2
MC33XX-S45 Premium	WLAN: IEEE® 802.11a/b/g/n/ac/d /h/i/k/r/w  WPAN: Bluetooth V4.1, V2.1 + EDR w/ Bluetooth Low Energy (BLE)  NFC	4.0" color	4 GB RAM / 16 GB Flash	SE4750-SR 2D	Android-based AOSP/GMS 7.1.2
MC33XX-S45 Premium +	WLAN: IEEE® 802.11a/b/g/n/ac/d /h/i/k/r/w  WPAN: Bluetooth V4.1, V2.1 + EDR w/ Bluetooth Low Energy (BLE)  NFC	4.0" color	4 GB RAM / 32 GB Flash	SE4750-SR 2D	Android-based AOSP/GMS 7.1.2

---

## Software Versions

- To determine the current software versions touch  >  **About phone**.
- **Model** – Displays the model number.
- **Android version** – Displays the operating system version.
- **Kernel version** – Displays the kernel version number.
- **Build number** – Displays the software build number.

To determine the device serial number touch  >  **About phone > Status**.

- **Serial number** - Displays the serial number.

---

## Chapter Descriptions

Topics covered in this guide are as follows:

- [Getting Started](#) provides information on getting the MC33XX up and running for the first time.
- [Accessories](#) describes the available accessories and how to use them with the MC33XX.
- [USB Communication](#) describes how to connect the MC33XX to a host computer using USB.
- [Datawedge Configuration](#) describes how to use and configure the DataWedge application.
- [Settings](#) provides the settings for configuring the MC33XX.
- [Application Deployment](#) provides information for developing and managing applications.
- [Maintenance and Troubleshooting](#) includes instructions on cleaning and storing the MC33XX, and provides troubleshooting solutions for potential problems during MC33XX operation.
- [Technical Specifications](#) provides the technical specifications for the MC33XX.
- [Keypad Remap Strings](#) provides keypad remap strings.

---

## Notational Conventions

The following conventions are used in this document:

- **Bold** text is used to highlight the following:
  - Dialog box, window and screen names
  - Drop-down list and list box names
  - Check box and radio button names
  - Button names on a screen.
- Bullets (•) indicate:
  - Action items
  - Lists of alternatives
  - Lists of required steps that are not necessarily sequential.
- Sequential lists (e.g., those that describe step-by-step procedures) appear as numbered lists.



---

### Icon Conventions

The documentation set is designed to give the reader more visual clues. The following graphic icons are used throughout the documentation set. These icons and their associated meanings are described below.



**NOTE:** NOTE contains information more important than the surrounding text, such as exceptions or preconditions. They also refer the reader elsewhere for additional information, remind the reader how to complete an action (when it is not part of the current procedure, for instance), or tell the reader where something is located on the screen. There is no warning level associated with a note.



**CAUTION:**The word CAUTION with the associated safety icon implies information that, if disregarded, may result in minor or moderate injury, or serious product damage.



**WARNING:** The word WARNING with the associated safety icon implies information that, if disregarded, could result in death or serious injury, or serious product damage.

---

### Related Documents and Software

The following documents provide more information about the MC33XX mobile computers.

- MC33XX Mobile Computer Quick Start Guide for Android 7.1.2 Nougat, p/n MN-003143-XX
- MC33XX Regulatory Guide, p/n MN-003144-XX
- MC33XX Mobile Computer User Guide for Android 7.1.2 Nougat, p/n MN-003131-XX

For the latest version of this guide and all guides, go to: <http://www.zebra.com/support>.

---

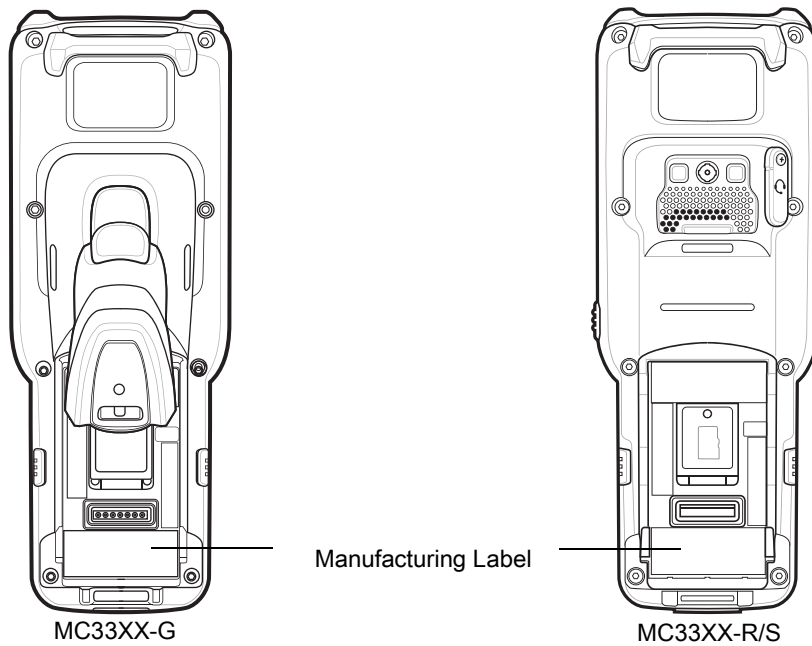
## Service Information

If you have a problem with your equipment, contact Zebra Support Center for your region. Contact information is available at: [www.zebra.com/support](http://www.zebra.com/support).

When contacting the Zebra Support Center, please have the following information available:

- Serial number of the unit (found on manufacturing label)
- Model number or product name (found on manufacturing label)
- Software type and version number.

**Figure 1** Manufacturing Label



Zebra responds to calls by email or telephone within the time limits set forth in support agreements.

If the problem cannot be solved by the Zebra Support Center, the user may need to return the equipment for servicing and will be given specific directions. Zebra is not responsible for any damages incurred during shipment if the approved shipping container is not used. Shipping the units improperly can possibly void the warranty.

Remove the microSD card from the device before shipping for service.

If you purchased your product from a Zebra business partner, contact that business partner for support.

---

## Provide Documentation Feedback

If you have comments, questions, or suggestions about this guide, send an email to [EVM-Techdocs@zebra.com](mailto:EVM-Techdocs@zebra.com).

# Getting Started

---

## Introduction

This chapter provides information for getting the device up and running for the first time.

---

## Setup

To start using the MC33XX for the first time:

- Install a microSD card (optional)
- Install the battery
- Charge the MC33XX
- Power on the MC33XX.

### Installing a microSD Card

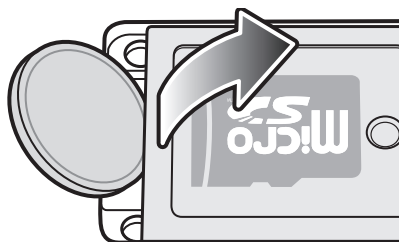
The microSD card slot provides secondary non-volatile storage. The slot is located under the battery pack. Refer to the documentation provided with the card for more information, and follow the manufacturer's recommendations for use.



**CAUTION:** Follow proper electrostatic discharge (ESD) precautions to avoid damaging the microSD card. Proper ESD precautions include, but are not limited to, working on an ESD mat and ensuring that the operator is properly grounded.

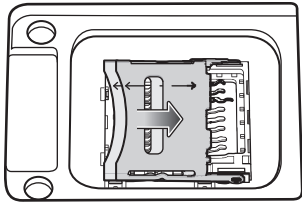
1. Using a coin or finger, remove the microSD card cover.

**Figure 2** Remove microSD Card Cover



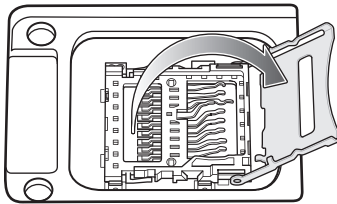
2. Slide the microSD card holder to the Open position.

**Figure 3** Unlock microSD Card Holder



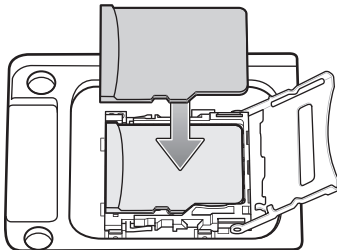
3. Lift the microSD card holder.

**Figure 4** Lift microSD Card Holder



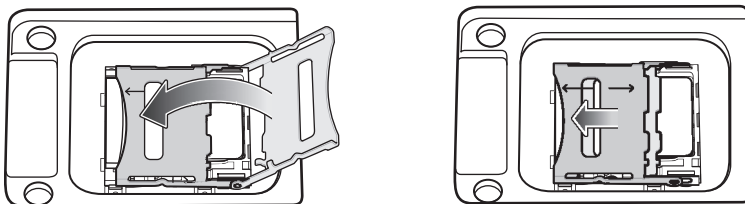
4. Place the microSD card into the contact area with the contacts facing down.

**Figure 5** Install microSD Card



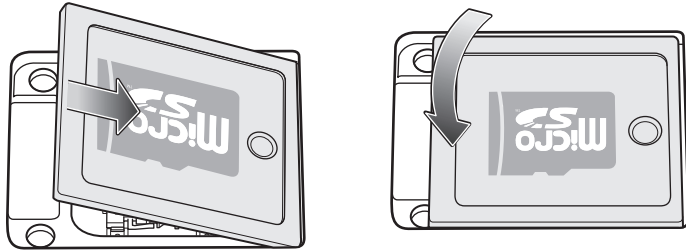
5. Close the microSD card holder and slide the microSD card holder to the Lock position.

**Figure 6** Lock microSD Card Holder



6. Replace the microSD card cover and ensure that it is installed properly.

**Figure 7** Replace Cover



## Installing the MC33XX-G Battery

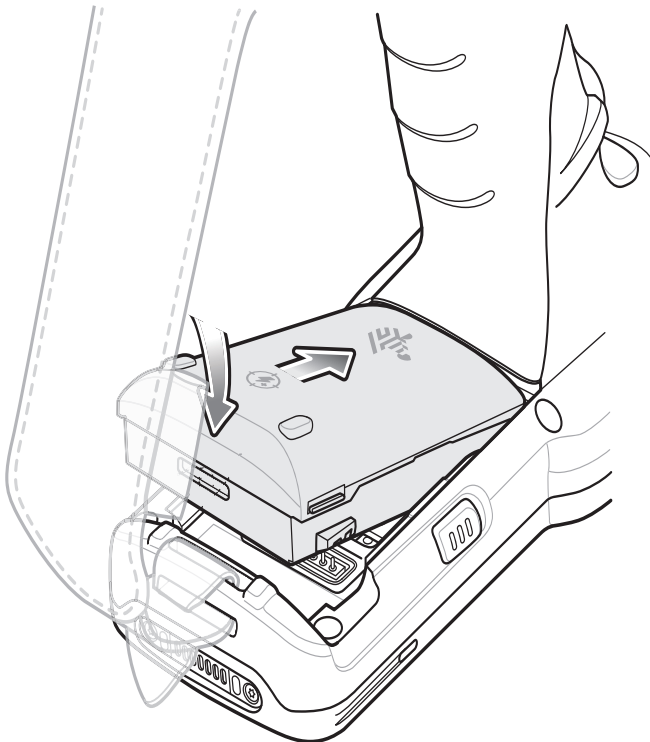
The MC33XX-G is compatible with the following batteries:

- MC33XX 5200 mAh PowerPrecision+ extended battery.
- MC32N0 5200 mAh PowerPrecision extended battery.

To install the battery:

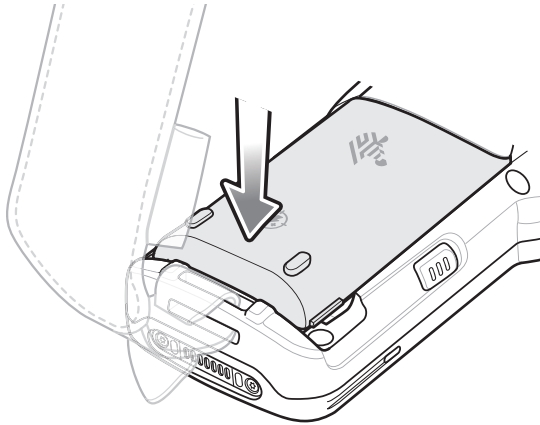
1. Loosen the hand strap, if needed.
2. Align the battery into the battery compartment.

**Figure 8** Inserting the Battery



3. Rotate the bottom of the battery into the battery compartment.
4. Press battery down firmly. Ensure that both battery release buttons on the sides of the MC33XX-G return to the home position.

**Figure 9** Press Battery Down



5. Tighten the hand strap, if needed.
6. Press the Power button to turn on the device.

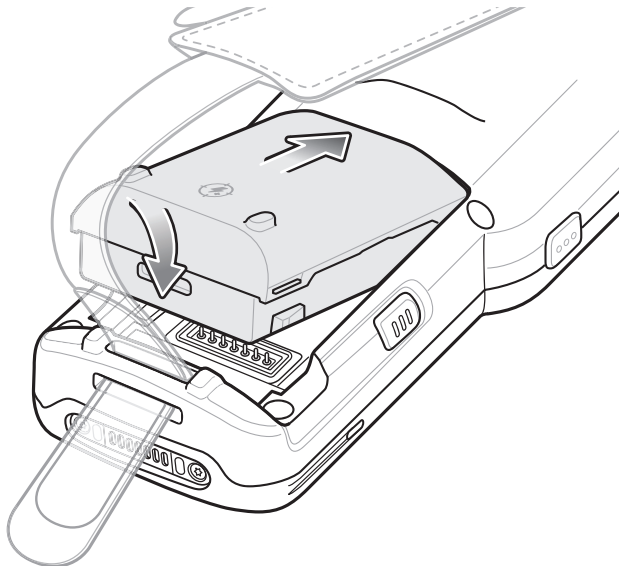
## Installing the MC33XX-R/S Battery

The MC33XX-R/S is compatible with the following batteries:

- MC33XX 2740 mAh PowerPrecision+ standard battery.
- MC33XX 5200 mAh PowerPrecision+ extended battery.
- MC32N0 2740 mAh PowerPrecision standard battery.
- MC32N0 5200 mAh PowerPrecision extended battery.

1. Loosen the hand strap, if needed.
2. Align the top of the battery into the battery compartment.

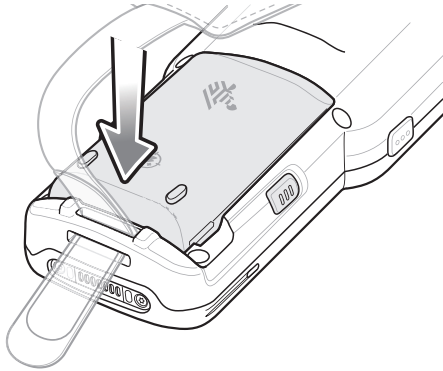
**Figure 10** Insert Battery



3. Rotate the bottom of the battery into the battery compartment.

4. Press battery down firmly. Ensure that both battery release buttons on the sides of the MC33XX-R/S return to the home position.

**Figure 11** Press Battery Down



5. Tighten the hand strap, if needed.
6. Press the Power button to turn on the device.

## Charging the Battery



**CAUTION:** Ensure that you follow the guidelines for battery safety described in [Battery Safety Guidelines on page 183](#).

Use the mobile computer cradles, cables and spare battery chargers to charge the mobile computer main battery.

The main battery can be charged before insertion into the mobile computer or after it is installed. There are two main batteries for the MC33XX, the 2740 mAh PowerPrecision+ standard battery (1X) and the 5200 mAh PowerPrecision+ extended battery (2X). The MC33XX-G is compatible with the 5200 mAh PowerPrecision+ extended battery. The MC33XX-R/S are compatible with both the 2740 mAh PowerPrecision+ standard battery and the 5200 mAh PowerPrecision+ extended battery. Use one of the spare battery chargers to charge the main battery (out of the mobile computer) or one of the cradles to charge the main battery while it is installed in the mobile computer.

Before using the mobile computer for the first time, fully charge the main battery until the green Charge LED indicator remains lit and charge the battery using a cable or a cradle with the appropriate power supply. For information about the accessories available for the MC33XX, see [Accessories](#). The 2740 mAh PowerPrecision+ standard battery fully charges (0% to 90% capacity) in less than 2.2 hours and the 5200 mAh PowerPrecision+ extended battery fully charges (0% to 90% capacity) in less than 3.8 hours.

The MC33XX retains data in memory for at least five minutes when the mobile computer's main battery is removed.

When the main battery reaches a very low battery state, the battery retains data in memory for at least 15 hours.

Batteries must be charged within the 0° to +40° C (32° to 104° F) ambient temperature range.

The following accessories can be used to charge batteries:

- Cradles (and a power supply):
  - 1-Slot USB Charge Cradle
  - 5-Slot Charge Only ShareCradle
  - 5-Slot Ethernet ShareCradle
  - 5-Slot Charge ShareCradle + 4-Slot Spare Battery Charger
  - 5-Slot Ethernet ShareCradle + 4-Slot Spare Battery Charger.
- Cables (and a power supply):
  - USB Charge Cable.
- Spare Battery Chargers (and a power supply):
  - 4-Slot Spare Battery Charger
  - 20-Slot Spare Battery Charger.

To charge the mobile computer using the cradles:

1. Insert the mobile computer into a cradle. See [Accessories](#) for accessory setup.
2. The mobile computer starts to charge automatically. The Charge LED Indicator indicates the charge status. See the table below for charging indications.

To charge the mobile computer using the cables:

1. Connect the MC33XX Communication/Charge Cable to the appropriate power source and connect to the mobile computer. See [Accessories](#) for accessory setup.
2. The mobile computer starts to charge automatically. The Charge LED Indicator indicates the charge status.

### LED Charge Indicators

Status	Indications
Off	<ul style="list-style-type: none"> <li>• The battery is not charging.</li> <li>• The battery is not inserted correctly in the cradle or connected to a power source.</li> <li>• Cradle is not powered.</li> </ul>
Slow Blinking Amber Every 3 seconds	<ul style="list-style-type: none"> <li>• Battery is charging, but the battery is fully depleted and does not yet have sufficient charge to power the device.</li> </ul>
Solid Amber	<ul style="list-style-type: none"> <li>• Battery is charging.</li> </ul>
Solid Green	<ul style="list-style-type: none"> <li>• Battery charging is complete.</li> </ul>
Fast Blinking Red 2 blinks/second	Charging error, e.g.: <ul style="list-style-type: none"> <li>• Temperature is too low or too high.</li> <li>• Charging has gone on too long without completion (typically eight hours).</li> </ul>
Solid Red	<ul style="list-style-type: none"> <li>• Spare battery is charging and battery is at the end of useful life.</li> <li>• Charging complete and battery is at the end of useful life.</li> </ul>

The MC33XX 2740 mAh PowerPrecision+ standard battery charges from 0% to 90% in less than 2.2 hours at room temperature.



The MC33XX 5200 mAh PowerPrecision+ extended battery charges from 0% to 90% in less than 3.8 hours at room temperature.

The MC32N0 2740 mAh PowerPrecision standard battery charges from 0% to 90% in less than 3 hours at room temperature.

The MC32N0 5200 mAh PowerPrecision extended battery charges from 0% to 90% in less than 5.5 hours at room temperature.

### Backup Power

The MC33XX is equipped with a supercapacitor (supercap) to provide backup power to the device when the main battery is removed. The supercap will retain random access memory (RAM) data in memory for approximately five minutes after the main battery is removed during Hot Swap.



**IMPORTANT:** The supercap is automatically charged from the main battery and requires approximately ten minutes to fully charge.

### Charging Temperature

Charge batteries in ambient temperatures from 0°C to 40°C (32°F to 104°F) or up to 45°C (113°F) as reported by the battery. To view the battery temperature, touch  >  **About phone** > **Battery information**.

Note that charging is intelligently controlled by the MC33XX. To accomplish this, for small periods of time, the MC33XX or accessory alternately enables and disables battery charging to keep the battery at acceptable temperatures. The MC33XX or accessory indicates when charging is disabled due to abnormal temperatures via its LED.

### Charging Spare Batteries

See [Accessories](#) for information on using accessories to charge spare batteries.

## Hot Swap Mode

The MC33XX provides a Hot Swap mode where the user can replace the battery without powering off the device. When the user removes the battery, the display turns off and the device enters a low power state while in Hot Swap mode. In Hot Swap mode, the MC33XX retains RAM data for approximately five minutes. Replace the battery within five minutes to preserve memory persistence. If the user does not install a charged battery within five minutes, data in RAM will be lost. During Hot Swap mode, Wi-Fi and Bluetooth remain connected for 30 seconds. If the battery is not inserted within 30 seconds, Wi-Fi is disabled and then re-enabled when the device comes out of Hot Swap mode and Bluetooth is reset when the device comes out of Hot Swap mode.



**IMPORTANT:** The supercap requires time to recharge after performing a Hot Swap or after the main battery is fully depleted. Hot Swap mode will not retain data unless the supercap is fully charged.

## Google Account Setup



**NOTE:** The MC33XX has to be connected to the internet in-order to set up a Google™ account. Google account only required on devices with GMS software.

The first time the MC33XX starts, the Setup Wizard displays. Follow the on-screen instructions to set up a Google account, configure Google Wallet for purchasing items from the Play Store, entering your personal information, and enabling backup/restore features.

---

## Resetting the Device

There are four reset functions:

- Soft reset
- Hard reset
- Enterprise reset. See [Performing an Enterprise Reset on page 198](#).
- Factory reset. See [Performing a Factory Reset on page 199](#).

### Performing a Soft Reset

Perform a soft reset if applications stop responding.

1. Press and hold the Power button until the menu appears.
2. Touch **Reboot** and then select **OK**.
3. The device reboots.

### Performing a Hard Reset

Perform a Hard Reset if the MC33XX stops responding.



**CAUTION:** Performing a hard reset with a SD card installed in the MC33XX may cause damage or data corruption to the SD card.

1. Simultaneously press the Power button, 1 and 9 keys.
2. When the screen turns off, release the buttons.
3. The device reboots.

# Accessories

---

## Introduction

This chapter provides information for using the accessories for the device.

---

## MC33XX Accessories

The table below lists the accessories available for the MC33XX.

**Table 2** MC33XX Accessories

Accessory	Part Number	Description
<b>Cradles</b>		
1-Slot USB Charge Cradle with Spare Battery Charger	CRD-MC33-2SUCHG-01	Charges the MC33XX main battery and a spare battery, and synchronizes the MC33XX with a host computer through a USB connection. Requires power supply (PWR-BGA12V50W0WW), DC line cord (CBL-DC-388A1-01) and a country specific grounded AC line cord.
5-Slot Charge Only ShareCradle	CRD-MC33-5SCHG-01	Charge only. Charges up to five MC33XXs. Requires power supply (PWR-BGA12V108W0WW), DC line cord (CBL-DC-381A1-01) and a country specific grounded AC line cord.
5-Slot Ethernet ShareCradle	CRD-MC33-5SETH-01	Charges up to five MC33XXs and provides Ethernet communication for up to five devices. Requires power supply (PWR-BGA12V108W0WW), DC line cord (CBL-DC-381A1-01) and a country specific grounded AC line cord.

**Table 2** MC33XX Accessories (Continued)

Accessory	Part Number	Description
5-Slot Charge ShareCradle with 4-Slot Battery Charger	CRD-MC33-4SC4BC-01	Charge only. Charges up to four MC33XXs and up to four spare batteries. Requires power supply (PWR-BGA12V108W0WW), DC line cord (CBL-DC-381A1-01) and a country specific grounded AC line cord.
5-Slot Ethernet ShareCradle with 4-Slot Battery Charger	CRD-MC33-4SE4BC-01	Charges up to four MC33XXs and up to four spare batteries and provides Ethernet communication for up to four MC33XXs. Requires power supply (PWR-BGA12V108W0WW), DC line cord (CBL-DC-381A1-01) and a country specific grounded AC line cord.
<b>Chargers</b>		
4-Slot Spare Battery Charger	SAC-MC33-4SCHG-01	Charges up to four MC33XX spare batteries. Requires power supply (PWR-BGA12V50W0WW), DC line cord (CBL-DC-388A1-01) and a country specific grounded AC line cord.
20-Slot Spare Battery Charger	SAC-MC33-20SCHG-01	Charges up to 20 MC33XX spare batteries. Requires power supply (PWR-BGA12V108W0WW), DC line cord (CBL-DC-381A1-01) and a country specific grounded AC line cord.
Power Supply	PWR-BGA12V50W0WW	Level VI power supply. Provides 12 VDC, 2.5A power to the 1-Slot USB Charge Cradle and the 4-Slot Spare Battery Charger. Requires a DC line cord (CBL-DC-388A1-01) and a country specific grounded AC line cord.
Power Supply	PWR-BGA12V108W0W W	Level VI power supply. Provides 12 VDC, 2.5A power to the 5-Slot Charge Only Cradle, 5-Slot Ethernet Cradle, 5-Slot Charge Cradle with 4-Slot Battery Charger, 5-Slot Ethernet Cradle with 4-Slot Battery Charger and 20-Slot Battery Charger. Requires a DC line cord (CBL-DC-381A1-01) and a country specific grounded AC line cord.

## Accessories

**Table 2** MC33XX Accessories (Continued)

Accessory	Part Number	Description
Power Supply	PWR-WUA5V12W0US	Wall adapter; Provides 12 VDC, 2.5A power to the USB Charge Cable. Includes plug adapter for use in the United States.
Power Supply	PWR-WUA5V12W0GB	Provides 12 VDC, 2.5A power to the USB Charge Cable. Includes plug adapter for use in the European Union.
Power Supply	PWR-WUA5V12W0EU	Provides 12 VDC, 2.5A power to the USB Charge Cable. Includes plug adapter for use in the United Kingdom.
Power Supply	PWR-WUA5V12W0AU	Provides 12 VDC, 2.5A power to the USB Charge Cable. Includes plug adapter for use in Australia.
Power Supply	PWR-WUA5V12W0CN	Provides 12 VDC, 2.5A power to the USB Charge Cable. Includes plug adapter for use in China.
Power Supply	PWR-WUA5V12W0IN	Provides 12 VDC, 2.5A power to the USB Charge Cable. Includes plug adapter for use in India.
US AC Line Cord	23844-00-00R	Provides power to 3-wire power supplies PWR-BGA12V50W0WW and PWR-BGA12V108W0WW.
DC Line Cord	CBL-DC-381A1-01	Provides power from the power supply (PWR-BGA12V108W0WW) to the 5-Slot Charge Only Cradle, 5-Slot Ethernet Cradle, 5-Slot Charge Cradle with 4-Slot Battery Charger, 5-Slot Ethernet Cradle with 4-Slot Battery Charger and 20-Slot Battery Charger.
DC Line Cord	CBL-DC-388A1-01	Provides power from the power supply (PWR-BGA12V150W0WW) to the 1-Slot USB Charge Cradle and 4-Slot Battery Charger.
<b>Cables</b>		
USB Charge Cable	CBL-MC33-USBCHG-01	Provides power and/or communication over USB to the device. Requires wall adapter/power supply PWR-WUA5V12W0xx.
1-Slot Cradle USB Cable	25-124330-01R	Provides USB communication through the 1-Slot USB cradle to the host computer.

## Accessories

**Table 2** MC33XX Accessories (Continued)

Accessory	Part Number	Description
Headset Quick Disconnect Adapter Cable (2.5 mm)	25-124411-03R	Connects an RCH51, HS2100, or third party quick disconnect headset to the MC33XX-R/S.
<b>Miscellaneous</b>		
Cradle Adapter	ADP-MC33-CRDCUP-01	MC33XX Charge Only Adapter for backwards compatibility with MC32 cradles. Works with MC32N0 1-Slot USB Cradle, 4-Slot Charge Only Cradle, and 4-Slot Ethernet Cradles.
2740 mAh Battery (Standard PowerPrecision+)	BTRY-MC33-27MA-01	Replacement standard capacity battery.
	BTRY-MC33-27MA-10	Replacement standard capacity battery (10-pack).
	BTRY-MC33-27MA-IN	Replacement standard capacity battery (India).
5200 mAh Battery (Extended PowerPrecision+)	BTRY-MC33-52MA-01	Replacement extended capacity battery.
	BTRY-MC33-52MA-10	Replacement extended capacity battery (10-pack).
	BTRY-MC33-52MA-IN	Replacement extended capacity battery (India).
MC33XX-G Hand Strap	SG-MC33-HDSTPG-01	Replacement hand strap for the MC33XX-G. Hand strap loop holds an optional stylus (SG-TC7X-STYLUS-03).
MC33XX-R/S Hand Strap	SG-MC33-HDSTPB-01	Replacement hand strap for the MC33XX-R and MC33XX-S.
Lanyard	SG-MC33-LNYDB-01	Optional lanyard for holding the MC33XX.
Rigid Holster	SG-MC33-RDHLST-01	Provides a clip on holder for the MC33XX-R and MC33XX-S.
MC33XX-G Fabric Holster	SG-MC3021212-01R	Provides a soft, clip on holster and a shoulder strap for the MC33XX-G.
MC33XX-R/S Fabric Holster	SG-MC3X-SHLSTB-01	Provides a soft, clip on holder and a shoulder strap for the MC33XX-R and MC33XX-S.
Shoulder Strap	58-40000-007R	Universal shoulder strap.
Belt	11-08062-02R	Belt for fabric holster.
MC33XX-G Rubber Boot	SG-MC33-RBTG-01	Provides additional protection for wear and tear of the MC33XX-G.

## Accessories

**Table 2** MC33XX Accessories (Continued)

Accessory	Part Number	Description
MC33XX-S Rubber Boot	SG-MC33-RBTS-01	Provides additional protection for the MC33XX-S.
MC33XX-R Rubber Boot for Terminal	SG-MC33-RBTRD-01	Provides additional protection for the MC33XX-R (terminal).
MC33XX-R Rubber Boot for Turret Cup	SG-MC33-RBTRT-01	Provides additional protection for the MC33XX-R (turret cup).
Tempered Glass Screen Protector	MISC-MC33-SCRN-01	Provides additional protection for display (5-pack).
Stylus and Tether	SG-TC7X-STYLUS-03	Conductive carbon-filled stylus for capacitive touch panel; includes coiled tether (3-pack).
Un-powered Forklift Mount	MNT-MC33-FLCHKT-01	Un-powered forklift mount. Allows installing the device on a roll bar or square surface of a forklift. Includes: Forklift holder (MNT-MC33-FLCH-01), RAM double socket arm for 1" ball (MNT-RAM-B201U) and RAM forklift clamp 2.5" max width square rail base with 1" ball (MNT-RAM-B247U25).

## Compatibility

The table below displays compatibility between MC33XX and MC32N0 mobile computers and accessories.

**Table 3** Compatibility

	MC33XX PP+ Batteries	MC32N0 PP Batteries	MC33XX Cradles	MC32N0 Cradles	MC33XX Battery Charger	MC32N0 Battery Charger
MC33XX mobile computer	Yes	Yes	Yes	Yes w/adapter	N/A	N/A
MC32N0 mobile computer	No	Yes	No	Yes	N/A	N/A
MC33XX PP+ Battery	N/A	N/A	Yes	No	Yes	No
MC32N0 PP Battery	N/A	N/A	Yes	Yes	Yes	Yes

- MC33XX mobile computers are compatible with all batteries (MC33XX PowerPrecision+ and MC32N0 PowerPrecision).
- MC33XX mobile computers are compatible with all cradles.  
An additional adapter is needed to use any MC32N0 cradle slot, which provides charge only, no communication.
- MC33XX battery charger slots are compatible with all batteries (MC33XX PowerPrecision+ and MC32N0 PowerPrecision).
- MC32N0 mobile computers are not compatible with MC33XX cradles.

## Battery Comparison

The table below displays a comparison of the MC33XX batteries with the MC32N0 batteries.

**Table 4** Battery Comparison

Feature	MC32N0	MC33XX
Battery Type	PowerPrecision	PowerPrecision+
Includes Zebra and PowerPrecision+ recessed logos	No	Yes
Back Label	Grey	Blue

## Battery Compatibility

- MC33XX PowerPrecision+ batteries are compatible with all MC33XX mobile computers and accessories.
- MC33XX PowerPrecision+ batteries are not compatible with MC32N0 mobile computers and accessories.
- MC32N0 PowerPrecision batteries are compatible with all MC32N0 mobile computers and accessories.



## Accessories

- MC32N0 PowerPrecision batteries are compatible with all MC33XX mobile computers and accessories.
- The MC33XX-G is compatible with MC33XX 5200 mAh PowerPrecision+ extended batteries and MC32N0 5200 mAh PowerPrecision extended batteries.
- The MC33XX-R/S are compatible with MC33XX 2740 mAh PowerPrecision+ standard batteries, MC33XX 5200 mAh PowerPrecision+ extended batteries, MC32N0 2740 mAh PowerPrecision standard batteries, and MC32N0 5200 mAh PowerPrecision extended batteries.

## 1-Slot USB Charge Cradle

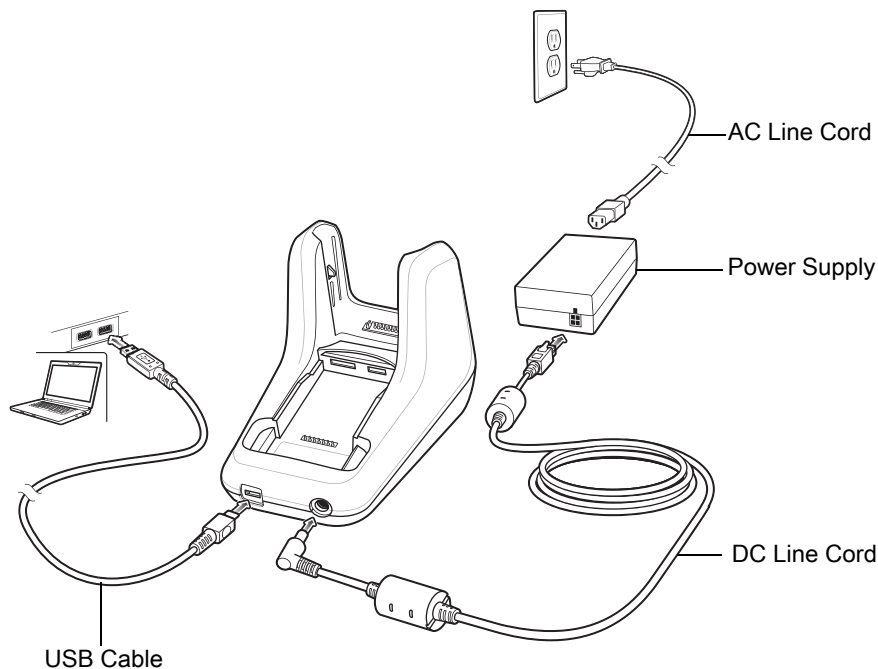


**CAUTION:** Ensure that you follow the guidelines for battery safety described in [Battery Safety Guidelines on page 214](#)

The 1-Slot USB Charge Cradle:

- Provides 9 VDC power for charging the mobile computer and charging the battery.
- Provides 4.2 VDC power to charge the spare battery.
- Provides a USB port for data communication between the mobile computer and a host computer or other USB devices (e.g., a printer).
- Synchronizes information between the mobile computer and a host computer. With customized or third party software, it can also synchronize the mobile computer with corporate databases.
- Compatible with the following batteries:
  - MC33XX 2740 mAh PowerPrecision+ standard battery.
  - MC33XX 5200 mAh PowerPrecision+ extended battery.
  - MC32N0 2740 mAh PowerPrecision standard battery.
  - MC32N0 5200 mAh PowerPrecision extended battery.

**Figure 12** 1-Slot USB Charge Cradle Setup



## Charging the MC33XX Battery



**NOTE:** To function properly, remove the lower part of the rubber boot or the entire rubber boot before placing in a charging cradle.

1. Ensure that the cradle is connected to power.
2. Slide the mobile computer into the slot in the cradle. The mobile computer Charge LED Indicator, indicates the mobile computer battery charging status. For charging status, see [Table 5 on page 36](#)

**Figure 13** MC33XX Battery Charging

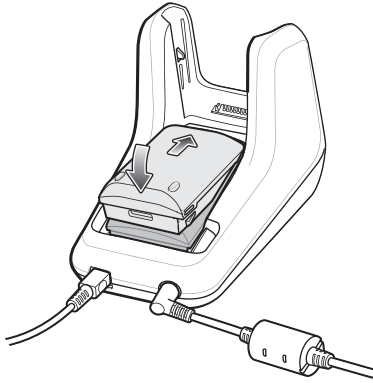


3. Gently press down on the device to ensure proper contact.
4. When charging is complete, remove the mobile computer from the cradle slot.

### Charging an MC33XX Spare Battery

1. Ensure that the cradle is connected to power.
2. Insert the spare battery into the cradle, bottom first, and pivot the top of the battery down onto the contact pins.

**Figure 14** MC33XX Spare Battery Charging



3. Gently press down on the battery to ensure proper contact.  
The Spare Battery Charging LED on the front of the cradle indicates the spare battery charging status.
4. When charging is complete, lift the battery out of the slot.

## Battery Charging in 1- Slot USB Charge Cradle

The 1-Slot USB charge cradle charges the MC33XX's main battery and a spare battery simultaneously.

The MC33XX's Charge LED indicates the status of the battery charging in the MC33XX. See [Table 5](#) for charging status indications.

The spare battery charging LED on the cradle indicates the status of the spare battery charging in the cradle. See below for charging status indications.

**Table 5** Spare Battery LED Charging Indicators

Spare Battery LED (on cradle)	Indication
Off	<ul style="list-style-type: none"> <li>The battery is not charging.</li> <li>The battery is not inserted correctly in the cradle or connected to a power source.</li> <li>Cradle is not powered.</li> </ul>
Solid Amber	<ul style="list-style-type: none"> <li>Battery is charging.</li> </ul>
Solid Green	<ul style="list-style-type: none"> <li>Battery charging is complete.</li> </ul>

**Table 5** Spare Battery LED Charging Indicators (Continued)

Spare Battery LED (on cradle)	Indication
Fast Blinking Red 2 blinks/second	Charging error, e.g.: <ul style="list-style-type: none"> <li>• Temperature is too low or too high.</li> <li>• Charging has gone on too long without completion (typically eight hours).</li> </ul>
Solid Red	<ul style="list-style-type: none"> <li>• Spare battery is charging and battery is at the end of useful life.</li> <li>• Charging complete and battery is at the end of useful life.</li> </ul>

The MC33XX 2740 mAh PowerPrecision+ standard battery charges from 0% to 90% in less than 2.2 hours at room temperature.

The MC33XX 5200 mAh PowerPrecision+ extended battery charges from 0% to 90% in less than 3.8 hours at room temperature.

The MC32N0 2740 mAh PowerPrecision standard battery charges from 0% to 90% in less than 3 hours at room temperature.

The MC32N0 5200 mAh PowerPrecision extended battery charges from 0% to 90% in less than 5.5 hours at room temperature.

### Charging Temperature

Charge batteries in temperatures from 0 °C to 40 °C (32 °F to 104 °F). Charging is intelligently controlled by the MC33XX.

To accomplish this, for small periods of time, the MC33XX or cradle alternately enables and disables battery charging to keep the battery at acceptable temperatures. The MC33XX or cradle indicates when charging is disabled due to abnormal temperatures via its LED.

## 5-Slot Charge Only ShareCradle

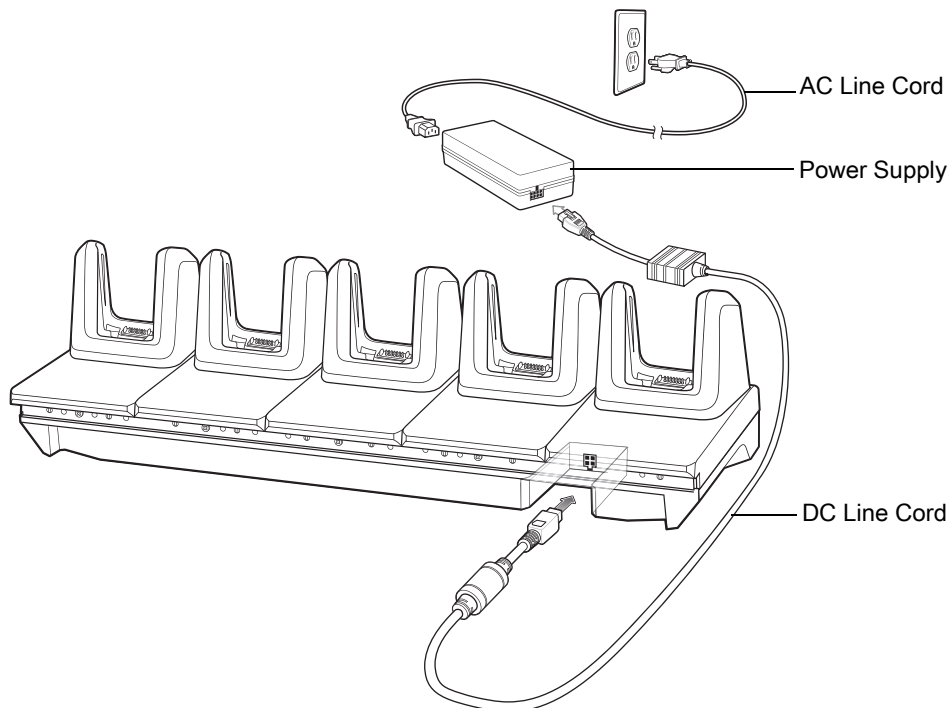


**CAUTION:** Ensure that you follow the guidelines for battery safety described in [Battery Safety Guidelines on page 214](#)

The 5-Slot Charge Only ShareCradle:

- Provides 9 VDC power for operating the mobile computer and charging the battery.
- Simultaneously charges up to five mobile computers.
- Compatible with devices using the following batteries:
  - MC33XX 2740 mAh PowerPrecision+ standard battery.
  - MC33XX 5200 mAh PowerPrecision+ extended battery.
  - MC32N0 2740 mAh PowerPrecision standard battery.
  - MC32N0 5200 mAh PowerPrecision extended battery.

**Figure 15** 5-Slot Charge Only ShareCradle Setup



## Charging the MC33XX Battery



**NOTE:** To function properly, remove the lower part of the rubber boot or the entire rubber boot before placing in a charging cradle.

1. Ensure that the cradle is connected to power.
2. Slide the mobile computer into the slot in the cradle. The mobile computer Charge LED Indicator, indicates the mobile computer battery charging status.
3. Gently press down on the device to ensure proper contact.

4. When charging is complete, remove the mobile computer from the cradle slot.

### **Battery Charging in the 5-Slot Charge Only ShareCradle**

The MC33XX's Charge LED indicates the status of the battery charging in the MC33XX. See [Table on page 24](#) for charging status indications.

The MC33XX 2740 mAh PowerPrecision+ standard battery charges from 0% to 90% in less than 2.2 hours at room temperature.

The MC33XX 5200 mAh PowerPrecision+ extended battery charges from 0% to 90% in less than 3.8 hours at room temperature.

The MC32N0 2740 mAh PowerPrecision standard battery charges from 0% to 90% in less than 3 hours at room temperature.

The MC32N0 5200 mAh PowerPrecision extended battery charges from 0% to 90% in less than 5.5 hours at room temperature.

### **Charging Temperature**

Charge batteries in temperatures from 0 °C to 40 °C (32 °F to 104 °F). Charging is intelligently controlled by the MC33XX.

To accomplish this, for small periods of time, the MC33XX or cradle alternately enables and disables battery charging to keep the battery at acceptable temperatures. The MC33XX or cradle indicates when charging is disabled due to abnormal temperatures via its LED.

## 5-Slot Ethernet ShareCradle

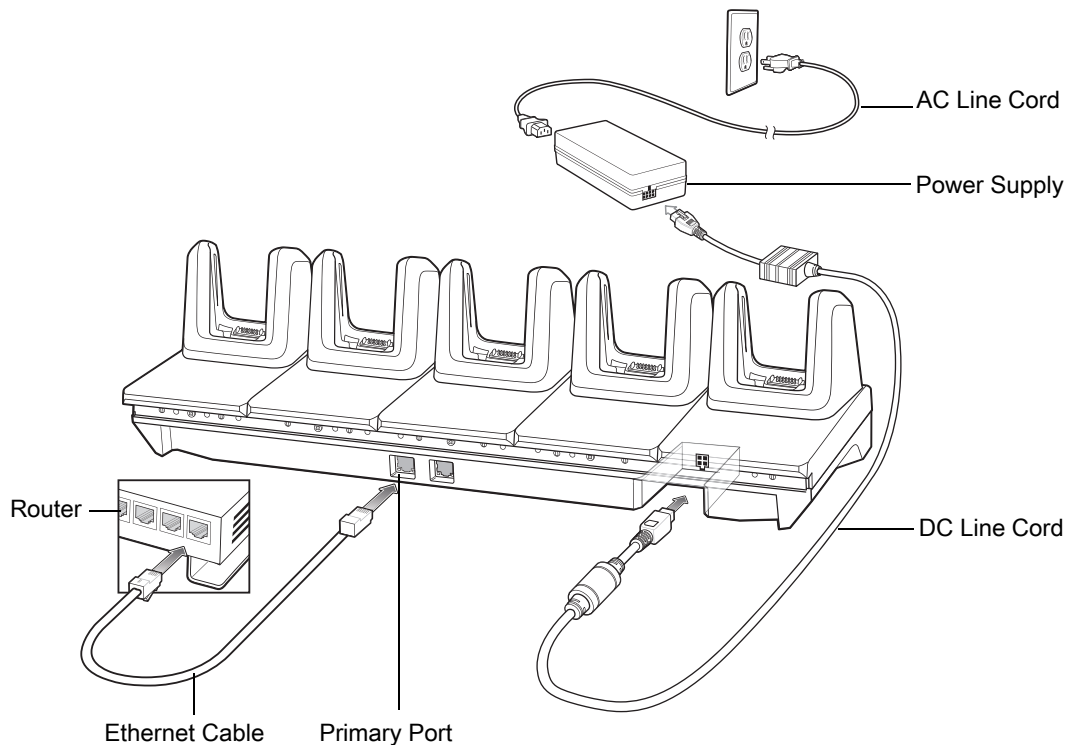


**CAUTION:** Ensure that you follow the guidelines for battery safety described in [Battery Safety Guidelines on page 214](#)

The 5-Slot Ethernet ShareCradle:

- Provides 9 VDC power for operating the mobile computer and charging the battery.
- Simultaneously charges up to five mobile computers.
- Compatible with devices using the following batteries:
  - MC33XX 2740 mAh PowerPrecision+ standard battery.
  - MC33XX 5200 mAh PowerPrecision+ extended battery.
  - MC32N0 2740 mAh PowerPrecision standard battery.
  - MC32N0 5200 mAh PowerPrecision extended battery.

**Figure 16** 5-Slot Ethernet ShareCradle Setup



## Charging the MC33XX Battery



**NOTE:** To function properly, remove the lower part of the rubber boot or the entire rubber boot before placing in a charging cradle.

1. Ensure that the cradle is connected to power.
2. Slide the mobile computer into the slot in the cradle. The mobile computer amber Charge LED Indicator, indicates the mobile computer battery charging status.



3. Gently press down on the device to ensure proper contact.
4. When charging is complete, remove the mobile computer from the cradle slot.

### Battery Charging in the 5-Slot Ethernet ShareCradle

The MC33XX's Charge LED indicates the status of the battery charging in the MC33XX. See [Table on page 24](#) for charging status indications.

The MC33XX 2740 mAh PowerPrecision+ standard battery charges from 0% to 90% in less than 2.2 hours at room temperature.

The MC33XX 5200 mAh PowerPrecision+ extended battery charges from 0% to 90% in less than 3.8 hours at room temperature.

The MC32N0 2740 mAh PowerPrecision standard battery charges from 0% to 90% in less than 3 hours at room temperature.

The MC32N0 5200 mAh PowerPrecision extended battery charges from 0% to 90% in less than 5.5 hours at room temperature.

### Charging Temperature

Charge batteries in temperatures from 0 °C to 40 °C (32 °F to 104 °F). Charging is intelligently controlled by the MC33XX.

To accomplish this, for small periods of time, the MC33XX or cradle alternately enables and disables battery charging to keep the battery at acceptable temperatures. The MC33XX or cradle indicates when charging is disabled due to abnormal temperatures via its LED.

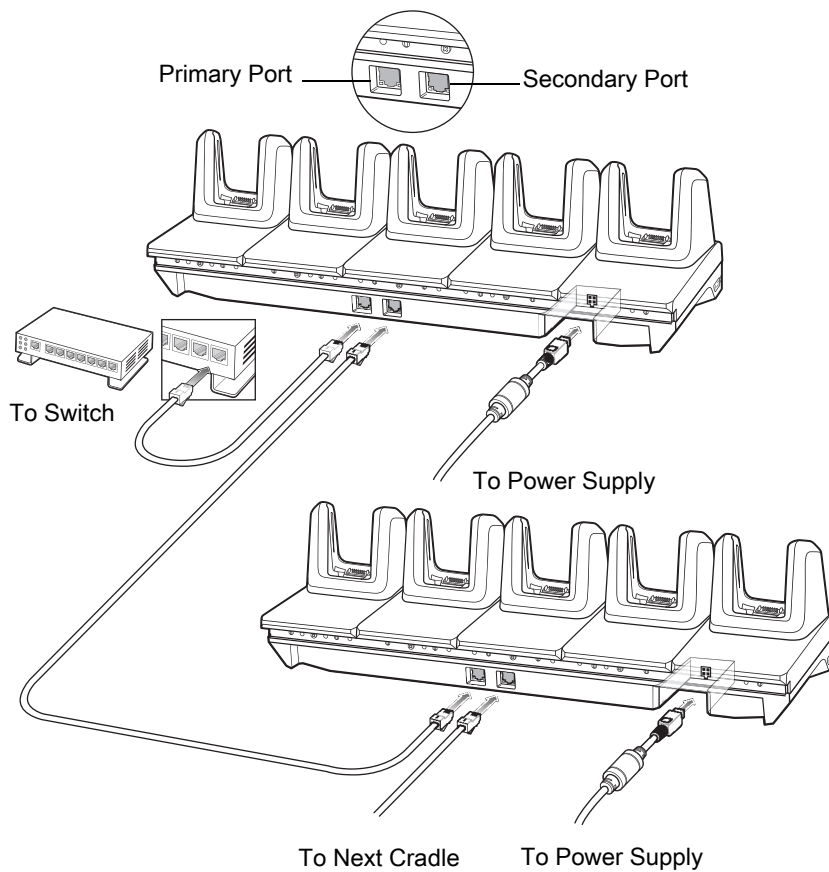
### Daisy-chaining Ethernet ShareCradles

Daisy-chain up to ten 5-Slot Ethernet ShareCradles to connect several cradles to an Ethernet network. Use either a straight or crossover cable. Daisy-chaining should not be attempted when the main Ethernet connection to the first cradle is 10 Mbps as throughput issues will almost certainly result.

To daisy-chain 5-Slot Ethernet ShareCradles:

1. Connect power to each 5-Slot Ethernet ShareCradle.
2. Connect an Ethernet cable to one of the ports on the switch and the other end to the Primary Port of the first cradle.
3. Connect an Ethernet cable to the Secondary port of the first cradle.
4. Connect the other end of the Ethernet cable to the Primary port of the next 5-Slot Ethernet ShareCradle.

**Figure 17** Daisy-chaining 5-Slot Ethernet ShareCradles



5. Connect additional cradles as described in step 3 and 4.



## Ethernet Settings

The following settings can be configured when using Ethernet communication:

- Proxy Settings
- Static IP.

## Configuring Ethernet Proxy Settings

The MC33XX includes Ethernet cradle drivers. After inserting the MC33XX, configure the Ethernet connection:

1. Swipe down from the status bar to open the quick access panel and then touch .
2. Touch  **Ethernet**.
3. Slide the switch to the **ON** position.
4. Place the MC33XX into the Ethernet cradle slot.
5. Touch and hold **eth0** until the menu appears.
6. Touch **Modify Proxy**.
7. Touch the **Proxy** drop-down list and select **Manual**.

**Figure 18** Ethernet Proxy Settings

eth0

Proxy  
Manual

Proxy hostname  
proxy.example.com

Proxy port  
8080

Bypass proxy for  
example.com,mycomp.test.com,k

CANCEL MODIFY



8. In the **Proxy hostname** field, enter the proxy server address.
9. In the **Proxy port** field, enter the proxy server port number.

✓ **NOTE:** When entering proxy addresses in the Bypass proxy for field, do not use spaces or carriage returns between addresses.

10. In the **Bypass proxy for** text box, enter addresses for web sites that do not require to go through the proxy server. Use the separator “|” between addresses.
11. Touch **MODIFY**.
12. Touch .

## Configuring Ethernet Static IP Address

The MC33XX includes Ethernet cradle drivers. After inserting the MC33XX, configure the Ethernet connection:

1. Swipe down from the status bar to open the quick access panel and then touch .
2. Touch  **Ethernet**.
3. Slide the switch to the **ON** position.
4. Place the MC33XX into the Ethernet cradle slot.
5. Touch **eth0**.
6. Touch **Disconnect**.
7. Touch **eth0**.
8. Touch the IP settings drop-down list and select **Static**.

**Figure 19** Static IP Settings

eth0

Proxy  
None

IP settings  
Static

IP address  
192.168.1.128

Gateway  
192.168.1.1

Netmask  
255.255.255.0



DNS 1  
8.8.8.8

DNS 2  
10.61.1.249

CANCEL DISCONNECT

9. In the **IP** address field, enter the proxy server address.
10. If required, in the **Gateway** field, enter a gateway address for the device.
11. If required, in the **Netmask** field, enter the network mask address
12. If required, in the **DNS** address fields, enter a Domain Name System (DNS) addresses.
13. Touch **CONNECT**.
14. Touch .

## Establishing Ethernet Connection

1. Swipe down from the status bar to open the quick access panel and then touch .
2. Touch **Ethernet**.
3. Slide the Ethernet switch to the **ON** position.
4. Insert the device into a slot.  
The  icon appears in the Status bar.
5. Touch **eth0** to view Ethernet connection details.

## LED Indicators

There are two green LEDs on the side of the cradle. These green LEDs light and blink to indicate the data transfer rate.

**Table 6** LED Data Rate Indicators

Data Rate	1000 LED	100/10 LED
1 Gbps	On/Blink	Off
100 Mbps	Off	On/Blink
10 Mbps	Off	On/Blink

## 5-Slot ShareCradle with 4-Slot Battery Charger

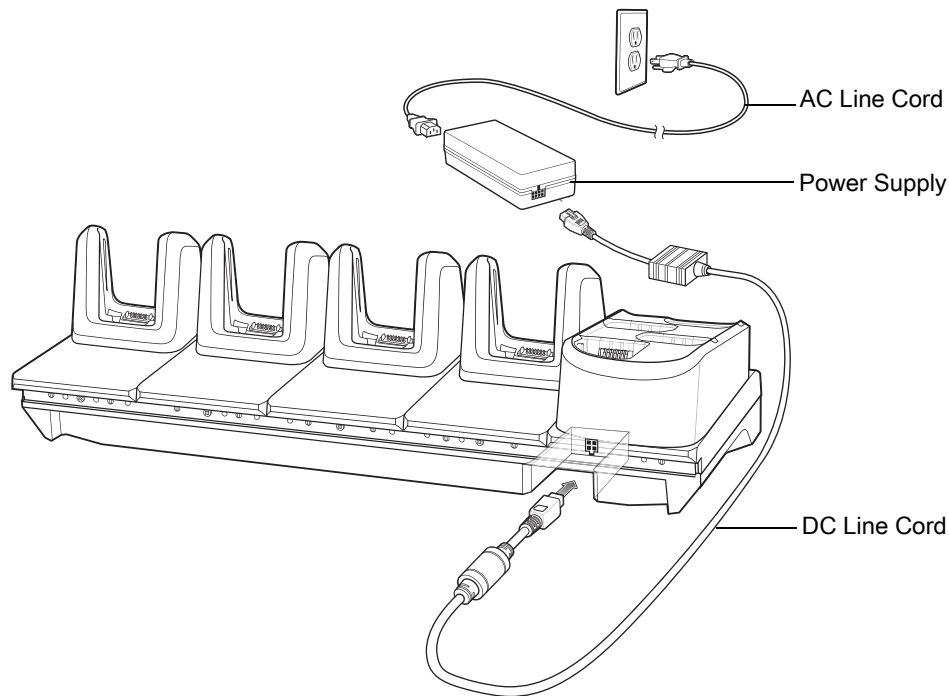


**CAUTION:** Ensure that you follow the guidelines for battery safety described in [Battery Safety Guidelines on page 214](#)

The 5-Slot ShareCradle with 4-Slot Battery Charger:

- Provides 9 VDC power for operating the mobile computer and charging the battery.
- Provides 4.2 VDC power for charging spare batteries.
- Simultaneously charges up to five mobile computers and four spare batteries.
- Compatible with the following batteries:
  - MC33XX 2740 mAh PowerPrecision+ standard battery.
  - MC33XX 5200 mAh PowerPrecision+ extended battery.
  - MC32N0 2740 mAh PowerPrecision standard battery.
  - MC32N0 5200 mAh PowerPrecision extended battery.

**Figure 20** 5-Slot ShareCradle with 4-Slot Battery Charger Setup



### Charging the MC33XX Battery



**NOTE:** To function properly, remove the lower part of the rubber boot or the entire rubber boot before placing in a charging cradle.

1. Ensure that the cradle is connected to power.

2. Slide the mobile computer into the slot in the cradle. The mobile computer amber Charge LED Indicator, indicates the mobile computer battery charging status.
3. Gently press down on the device to ensure proper contact.
4. When charging is complete, remove the mobile computer from the cradle slot.

### Charging Spare Batteries

Insert the battery into the charger and gently press down on the battery to ensure proper contact.

### Battery Charging in the 5-Slot ShareCradle with 4-Slot Battery Charger

The MC33XX's Charge LED or the spare battery LED indicates the status of the battery charging in the MC33XX. See [Table on page 24](#) for charging status indications.

The MC33XX 2740 mAh PowerPrecision+ standard battery charges from 0% to 90% in less than 2.2 hours at room temperature.

The MC33XX 5200 mAh PowerPrecision+ extended battery charges from 0% to 90% in less than 3.8 hours at room temperature.

The MC32N0 2740 mAh PowerPrecision standard battery charges from 0% to 90% in less than 3 hours at room temperature.

The MC32N0 5200 mAh PowerPrecision extended battery charges from 0% to 90% in less than 5.5 hours at room temperature.

### Charging Temperature

Charge batteries in temperatures from 0 °C to 40 °C (32 °F to 104 °F). Charging is intelligently controlled by the MC33XX.

To accomplish this, for small periods of time, the MC33XX or cradle alternately enables and disables battery charging to keep the battery at acceptable temperatures. The MC33XX or cradle indicates when charging is disabled due to abnormal temperatures via its LED.

## 5-Slot Ethernet ShareCradle with 4-Slot Battery Charger

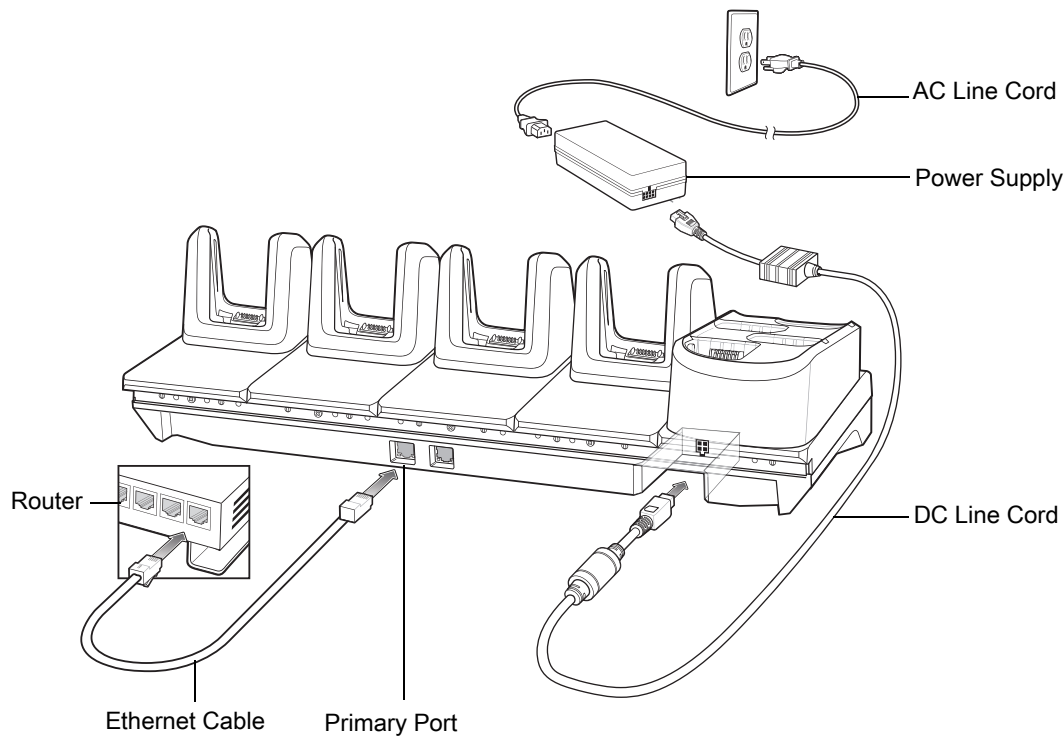


**CAUTION:** Ensure that you follow the guidelines for battery safety described in [Battery Safety Guidelines](#) on page 214

The 5-Slot Ethernet ShareCradle with 4-Slot Battery Charger:

- Provides 9 VDC power for operating the mobile computer and charging the battery.
- Provides 4.2 VDC power for charging spare batteries.
- Simultaneously charges up to five mobile computers and four spare batteries.
- Compatible with the following batteries:
  - MC33XX 2740 mAh PowerPrecision+ standard battery.
  - MC33XX 5200 mAh PowerPrecision+ extended battery.
  - MC32N0 2740 mAh PowerPrecision standard battery.
  - MC32N0 5200 mAh PowerPrecision extended battery.

**Figure 21** 5-Slot Ethernet ShareCradle with 4-Slot Battery Charger Setup



### Charging the MC33XX Battery



**NOTE:** To function properly, remove the lower part of the rubber boot or the entire rubber boot before placing in a charging cradle.

1. Ensure that the cradle is connected to power.



2. Slide the mobile computer into the slot in the cradle. The mobile computer amber Charge LED Indicator, indicates the mobile computer battery charging status.
3. Gently press down on the device to ensure proper contact.
4. When charging is complete, remove the mobile computer from the cradle slot.

### Charging Spare Batteries

Insert the battery into the charger and gently press down on the battery to ensure proper contact.

### Battery Charging in the 5-Slot Ethernet ShareCradle with 4-Slot Battery Charger

The MC33XX's Charge LED or the spare battery LED indicates the status of the battery charging in the MC33XX. See [Table on page 24](#) for charging status indications.

The MC33XX 2740 mAh PowerPrecision+ standard battery charges from 0% to 90% in less than 2.2 hours at room temperature.

The MC33XX 5200 mAh PowerPrecision+ extended battery charges from 0% to 90% in less than 3.8 hours at room temperature.

The MC32N0 2740 mAh PowerPrecision standard battery charges from 0% to 90% in less than 3 hours at room temperature.

The MC32N0 5200 mAh PowerPrecision extended battery charges from 0% to 90% in less than 5.5 hours at room temperature.

### Charging Temperature

Charge batteries in temperatures from 0 °C to 40 °C (32 °F to 104 °F). Charging is intelligently controlled by the MC33XX.

To accomplish this, for small periods of time, the MC33XX or cradle alternately enables and disables battery charging to keep the battery at acceptable temperatures. The MC33XX or cradle indicates when charging is disabled due to abnormal temperatures via its LED.

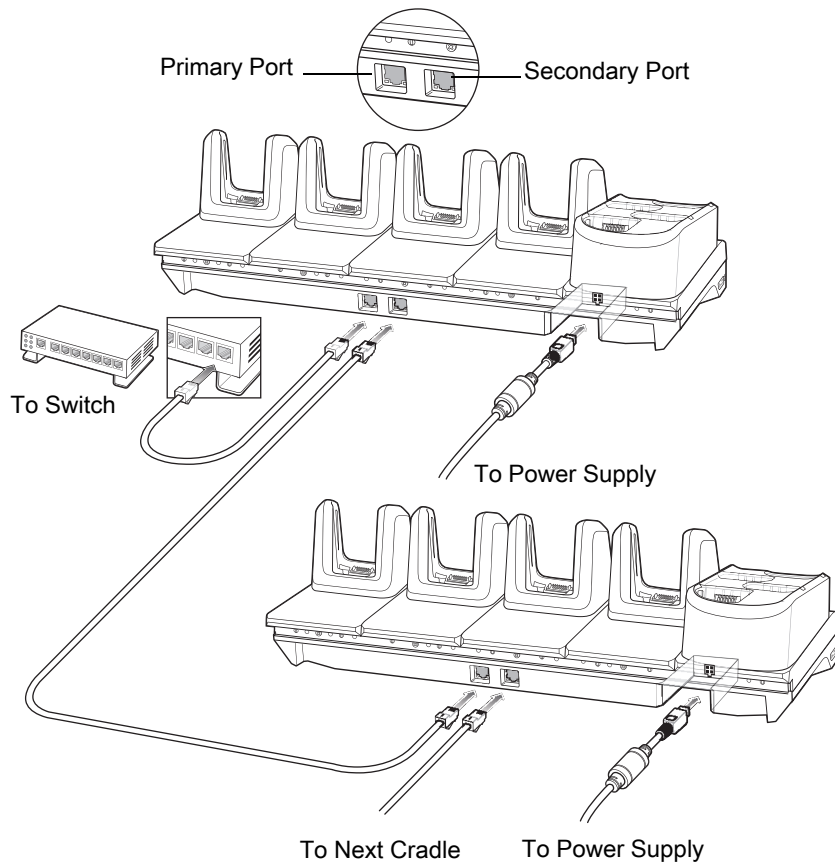
### Daisy-chaining Ethernet Cradles

Daisy-chain up to ten 5-Slot Ethernet ShareCradle with 4-Slot Battery Chargers to connect several cradles to an Ethernet network. Use either a straight or crossover cable. Daisy-chaining should not be attempted when the main Ethernet connection to the first cradle is 10 Mbps as throughput issues will almost certainly result.

To daisy-chain 5-Slot Ethernet ShareCradle with 4-Slot Battery Chargers:

1. Connect power to each 5-Slot Ethernet ShareCradle with 4-Slot Battery Charger.
2. Connect an Ethernet cable to one of the ports on the switch and the other end to the Primary Port of the first cradle.
3. Connect an Ethernet cable to the Secondary port of the first cradle.
4. Connect the other end of the Ethernet cable to the Primary port of the next 5-Slot Ethernet ShareCradle with 4-Slot Battery Charger.

**Figure 22** Daisy-chaining 5-Slot Ethernet ShareCradle with 4-Slot Battery Chargers



5. Connect additional cradles as described in step 3 and 4.



## Ethernet Settings

The following settings can be configured when using Ethernet communication:

- Proxy Settings
- Static IP.

## Configuring Ethernet Proxy Settings

The MC33XX includes Ethernet cradle drivers. After inserting the MC33XX, configure the Ethernet connection:

1. Swipe down from the status bar to open the quick access panel and then touch .
2. Touch  **Ethernet**.
3. Slide the switch to the **ON** position.
4. Place the MC33XX into the Ethernet cradle slot.
5. Touch and hold **eth0** until the menu appears.
6. Touch **Modify Proxy**.
7. Touch the **Proxy** drop-down list and select **Manual**.

**Figure 23** Ethernet Proxy Settings

eth0

Proxy  
Manual

Proxy hostname  
proxy.example.com

Proxy port  
8080

Bypass proxy for  
example.com,mycomp.test.com,k

CANCEL MODIFY



8. In the **Proxy hostname** field, enter the proxy server address.
9. In the **Proxy port** field, enter the proxy server port number.

✓ **NOTE:** When entering proxy addresses in the Bypass proxy for field, do not use spaces or carriage returns between addresses.

10. In the **Bypass proxy for** text box, enter addresses for web sites that do not require to go through the proxy server. Use the separator “|” between addresses.
11. Touch **MODIFY**.
12. Touch .

## Configuring Ethernet Static IP Address

The MC33XX includes Ethernet cradle drivers. After inserting the MC33XX, configure the Ethernet connection:

1. Swipe down from the status bar to open the quick access panel and then touch .
2. Touch  **Ethernet**.
3. Slide the switch to the **ON** position.
4. Place the MC33XX into the Ethernet cradle slot.
5. Touch **eth0**.
6. Touch **Disconnect**.
7. Touch **eth0**.
8. Touch the IP settings drop-down list and select **Static**.

**Figure 24** Static IP Settings

eth0

Proxy  
None

IP settings  
Static

IP address  
192.168.1.128

Gateway  
192.168.1.1

Netmask  
255.255.255.0



DNS 1  
8.8.8.8

DNS 2  
10.61.1.249

CANCEL DISCONNECT

9. In the **IP** address field, enter the proxy server address.
10. If required, in the **Gateway** field, enter a gateway address for the device.
11. If required, in the **Netmask** field, enter the network mask address
12. If required, in the **DNS** address fields, enter a Domain Name System (DNS) addresses.
13. Touch **CONNECT**.
14. Touch .

## Establishing Ethernet Connection

1. Swipe down from the status bar to open the quick access panel and then touch .
2. Touch **Ethernet**.
3. Slide the Ethernet switch to the **ON** position.
4. Insert the device into a slot.  
The  icon appears in the Status bar.
5. Touch **eth0** to view Ethernet connection details.

## LED Indicators

There are two green LEDs on the side of the cradle. These green LEDs light and blink to indicate the data transfer rate.

**Table 7** LED Data Rate Indicators

Data Rate	1000 LED	100/10 LED
1 Gbps	On/Blink	Off
100 Mbps	Off	On/Blink
10 Mbps	Off	On/Blink

## 4-Slot Spare Battery Charger



**CAUTION:** Ensure that you follow the guidelines for battery safety described in [Battery Safety Guidelines on page 214](#)

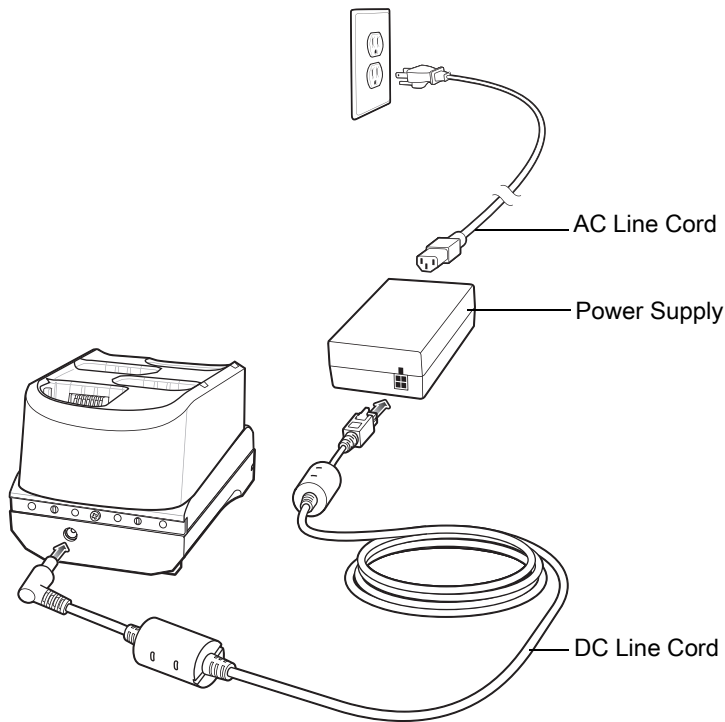
The 4-Slot Battery Charger:

- Charges up to four MC33XX spare batteries.
- Provides 4.2 VDC power to charge the spare battery.
- Compatible with the following batteries:
  - MC33XX 2740 mAh PowerPrecision+ standard battery.
  - MC33XX 5200 mAh PowerPrecision+ extended battery.
  - MC32N0 2740 mAh PowerPrecision standard battery.
  - MC32N0 5200 mAh PowerPrecision extended battery.

## Charging Spare Batteries

1. Connect the charger to a power source.
2. Insert the battery into the charger and gently press down on the battery to ensure proper contact.

**Figure 25** 4-Slot Battery Charger Setup



## Battery Charging

### Spare Battery Charging

Each Battery Charging LED indicates the status of the battery charging in each slot. The table below describes the Battery Charging LED status.

**Table 8** Battery LED Charging Indicators

LED	Indication
Off	<ul style="list-style-type: none"> <li>The battery is not charging.</li> <li>The battery is not inserted correctly in the cradle or connected to a power source.</li> <li>Cradle is not powered.</li> </ul>
Solid Amber	<ul style="list-style-type: none"> <li>Battery is charging.</li> </ul>
Solid Green	<ul style="list-style-type: none"> <li>Battery charging is complete.</li> </ul>
Fast Blinking Red 2 blinks/second	Charging error, e.g.: <ul style="list-style-type: none"> <li>Temperature is too low or too high.</li> <li>Charging has gone on too long without completion (typically eight hours).</li> </ul>
Solid Red	<ul style="list-style-type: none"> <li>Spare battery is charging and battery is at the end of useful life.</li> <li>Charging complete and battery is at the end of useful life.</li> </ul>

The MC33XX 2740 mAh PowerPrecision+ standard battery charges from 0% to 90% in less than 2.2 hours at room temperature.

The MC33XX 5200 mAh PowerPrecision+ extended battery charges from 0% to 90% in less than 3.8 hours at room temperature.

The MC32N0 2740 mAh PowerPrecision standard battery charges from 0% to 90% in less than 3 hours at room temperature.

The MC32N0 5200 mAh PowerPrecision extended battery charges from 0% to 90% in less than 5.5 hours at room temperature.

### Charging Temperature

Charge batteries in temperatures from 0 °C to 40 °C (32 °F to 104 °F). Charging is intelligently controlled by the MC33XX.

To accomplish this, for small periods of time, the charger alternately enables and disables battery charging to keep the battery at acceptable temperatures. The charger indicates when charging is disabled due to abnormal temperatures via its LED.

---

## 20-Slot Spare Battery Charger



**CAUTION:** Ensure that you follow the guidelines for battery safety described in [Battery Safety Guidelines on page 214](#)

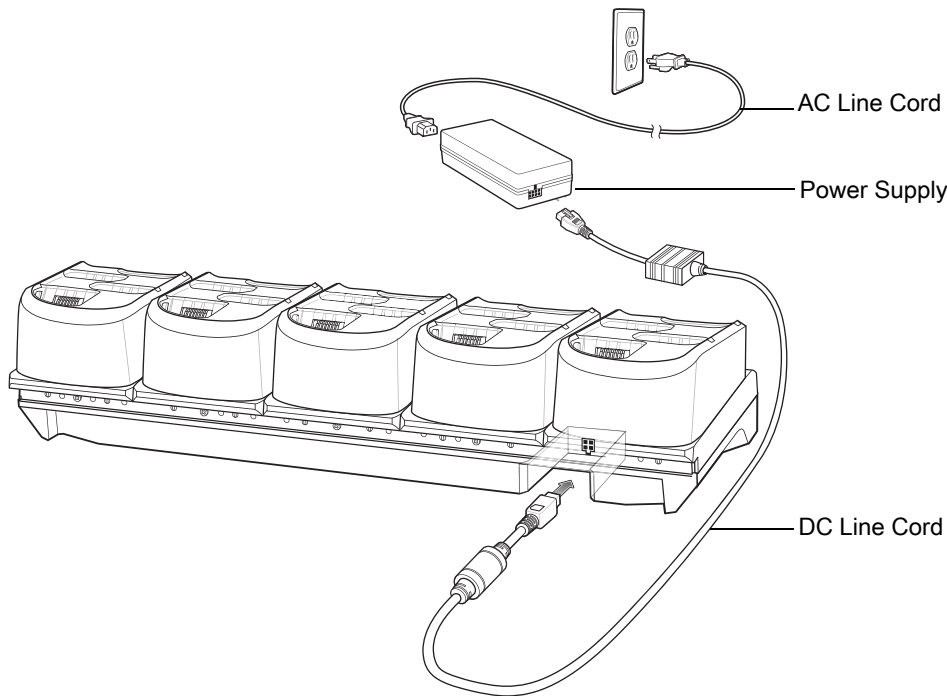
The 20-Slot Battery Charger:

- Charges up to twenty MC33XX spare batteries.
- Provides 4.2 VDC power to charge the spare battery.
- Compatible with the following batteries:
  - MC33XX 2740 mAh PowerPrecision+ standard battery.
  - MC33XX 5200 mAh PowerPrecision+ extended battery.
  - MC32N0 2740 mAh PowerPrecision standard battery.
  - MC32N0 5200 mAh PowerPrecision extended battery.

### Charging Spare Batteries

1. Connect the charger to a power source.
2. Insert the battery into the charger and gently press down on the battery to ensure proper contact.

**Figure 26** 20-Slot Battery Charger Setup



## Battery Charging

### Spare Battery Charging

Each Battery Charging LED indicates the status of the battery charging in each slot. The table below describes the Battery Charging LED status.

**Table 9** Battery LED Charging Indicators

LED	Indication
Off	<ul style="list-style-type: none"> <li>The battery is not charging.</li> <li>The battery is not inserted correctly in the cradle or connected to a power source.</li> <li>Cradle is not powered.</li> </ul>
Solid Amber	<ul style="list-style-type: none"> <li>Battery is charging.</li> </ul>
Solid Green	<ul style="list-style-type: none"> <li>Battery charging is complete.</li> </ul>
Fast Blinking Red 2 blinks/second	Charging error, e.g.: <ul style="list-style-type: none"> <li>Temperature is too low or too high.</li> <li>Charging has gone on too long without completion (typically eight hours).</li> </ul>
Solid Red	<ul style="list-style-type: none"> <li>Spare battery is charging and battery is at the end of useful life.</li> <li>Charging complete and battery is at the end of useful life.</li> </ul>



The MC33XX 2740 mAh PowerPrecision+ standard battery charges from 0% to 90% in less than 3 hours at room temperature.

The MC33XX 5200 mAh PowerPrecision+ extended battery charges from 0% to 90% in less than 5.5 hours at room temperature.

The MC32N0 2740 mAh PowerPrecision standard battery charges from 0% to 90% in less than 3 hours at room temperature.

The MC32N0 5200 mAh PowerPrecision extended battery charges from 0% to 90% in less than 5.5 hours at room temperature.

### **Charging Temperature**

Charge batteries in temperatures from 0 °C to 40 °C (32 °F to 104 °F). Charging is intelligently controlled by the MC33XX.

To accomplish this, for small periods of time, the charger alternately enables and disables battery charging to keep the battery at acceptable temperatures. The charger indicates when charging is disabled due to abnormal temperatures via its LED.

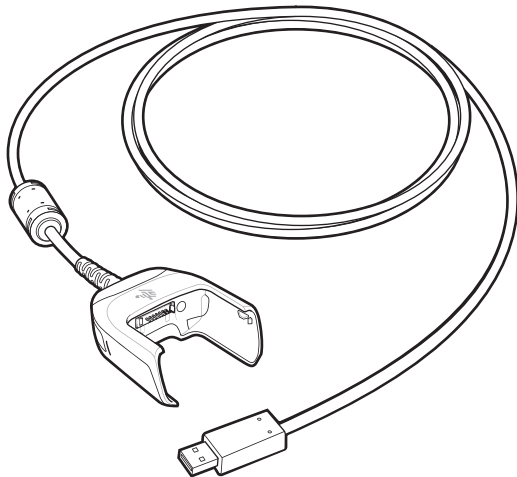
## USB Charge Cable

The USB Charge Cable:

- Provides 5 VDC power to charge the battery.
- Provides power and/or communication with the host computer over USB to the device.
- Compatible with devices using the following batteries:
  - MC33XX 2740 mAh PowerPrecision+ standard battery.
  - MC33XX 5200 mAh PowerPrecision+ extended battery.
  - MC32N0 2740 mAh PowerPrecision standard battery.
  - MC32N0 5200 mAh PowerPrecision extended battery.

The USB Charge Cable snaps onto the bottom of the MC33XX and removes easily when not in use. When attached to the MC33XX allows charging only.

**Figure 27** USB Charge Cable



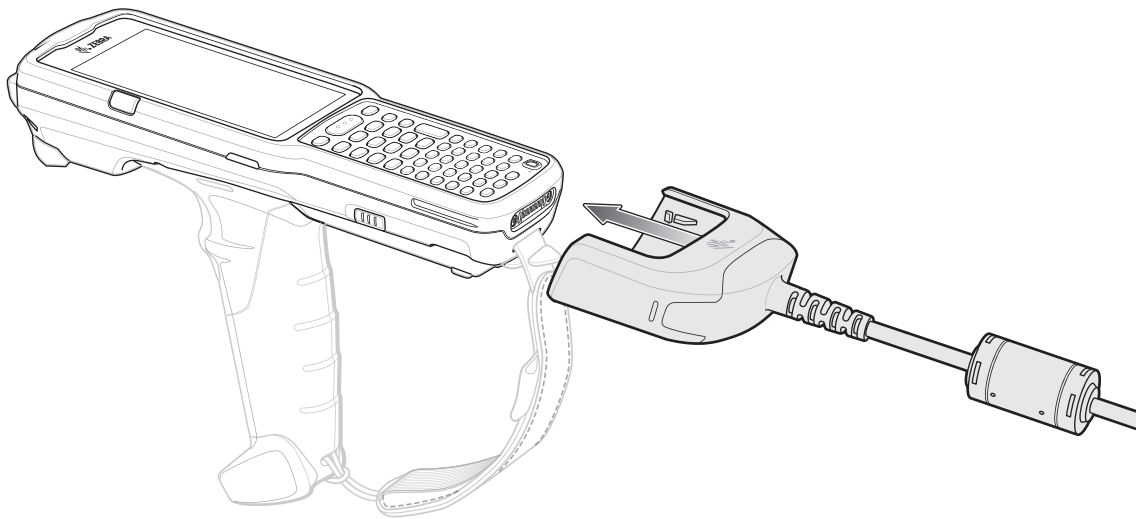
## Connecting the USB Charge Cable to Device



**NOTE:** To function properly, remove the lower part of the rubber boot or the entire rubber boot before placing in a charging cradle.

To connect the USB Charge Cable to the device, insert the USB Charge Cable straight onto the device until the device touches the bottom of the cable cup.

**Figure 28** Connecting the USB Charge Cable

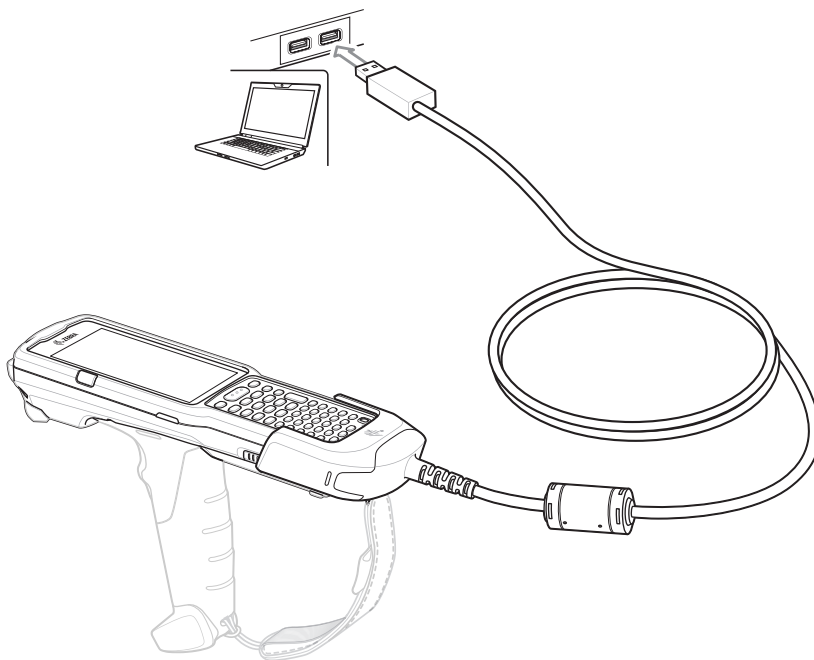


## Connecting the USB Charge Cable to Host Computer

To connect the USB Charge Cable to a host computer:

1. Connect the USB Charge Cable to the MC33XX.
2. Connect the USB connector of the cable to a host computer.

**Figure 29** Connecting USB Charge Cable to Host Computer



## Main Battery Charging

The device's Charging/Notification LED indicates the status of the battery charging in the device.



**NOTE:** Charging using a host computer USB port could take longer.

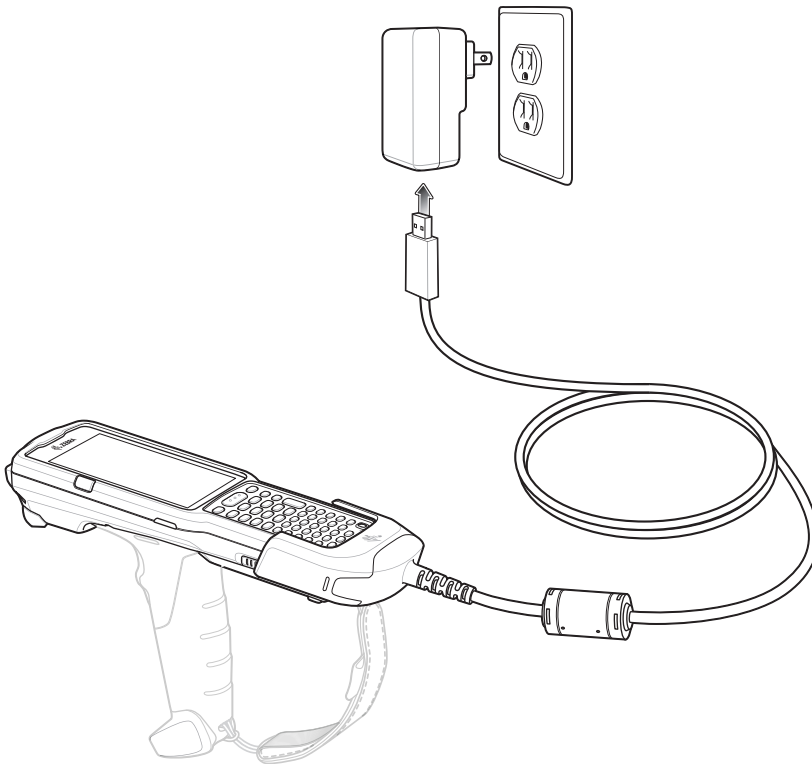
To achieve the best charging results use only Zebra charging accessories and batteries. Charge batteries at room temperature with the MC33XX in sleep mode.

## Charging the Device

To charge the device using the USB Charge Cable:

1. Connect the USB Charge Cable to the MC33XX.
2. Connect the USB connector of the power supply.
3. Plug the power supply into a power outlet.

**Figure 30** Charging the Device



## Main Battery Charging

The device's Charging/Notification LED indicates the status of the battery charging in the device.



**NOTE:** In many cases the 90% charge provides plenty of charge for daily use.

To achieve the best charging results use only Zebra charging accessories and batteries. Charge batteries at room temperature with the MC33XX in sleep mode.

The MC33XX 2740 mAh PowerPrecision+ standard battery charges from 0% to 90% in less than 2.2 hours at room temperature.

The MC33XX 5200 mAh PowerPrecision+ extended battery charges from 0% to 90% in less than 6 hours at room temperature.

The MC32N0 2740 mAh PowerPrecision standard battery charges from 0% to 90% in less than 3 hours at room temperature.

The MC32N0 5200 mAh PowerPrecision extended battery charges from 0% to 90% in less than 6 hours at room temperature.

### Disconnecting the USB Charge Cable

To disconnect the USB Charge Cable from the MC33XX:

1. Grasp the cable cup in one hand (by pinching the front and back) and the device in the other hand.
2. Remove the device by pulling straight up.

**Figure 31** Disconnecting the USB Charge Cable



## MC33XX Charge Only Adapter

Use the MC33XX Charge Only Adapter for backwards compatibility with the MC32N0 cradles and the MC33XX mobile computer.

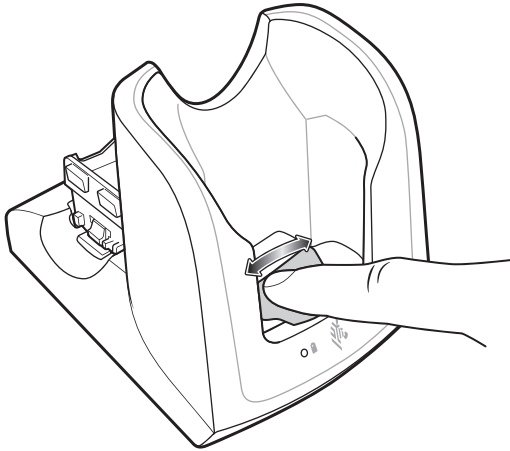
- MC33XX Charge Only Adapter supports the MC32N0 1-Slot USB Cradle, MC32N0 4-Slot Charge Only Cradle, and MC32N0 4-Slot Ethernet Cradle.
- MC33XX Charge Only Adapter provides charge only; no communication when used with the MC32N0 cradles.
- MC32N0 1-Slot USB Cradle provides 5.4V DC to charge the device.
- MC32N0 1-Slot USB Cradle (with the MC33XX Charge Only Adapter) is compatible with an MC33XX mobile computer charging either MC33XX PowerPrecision+ batteries or MC32N0 PowerPrecision batteries, but the MC32N0 1-Slot USB Cradle spare battery slot is only compatible with MC32N0 PowerPrecision batteries.

### Adapter Installation

To install the MC33XX Charge Only Adapter into the MC32N0 Cradle:

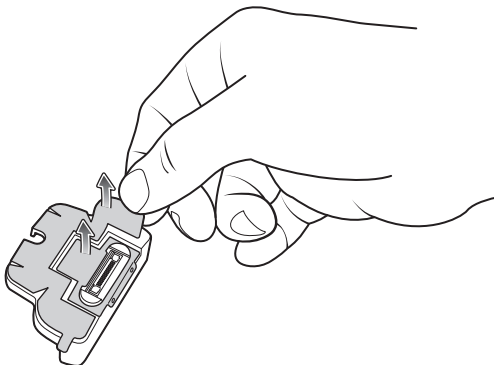
1. Clean the MC32N0 cradle and contacts with an alcohol wipe, using a back and forth motion with your finger. For more information about cleaning, see [Maintenance and Troubleshooting](#).

**Figure 32** Clean MC32N0 Cradle



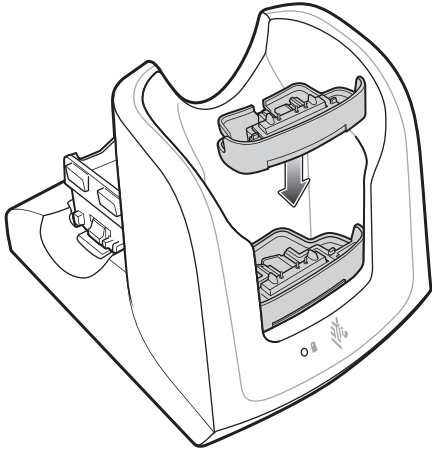
2. Peel and remove the adhesive from the back of the adapter.

**Figure 33** Peel and Remove Adhesive



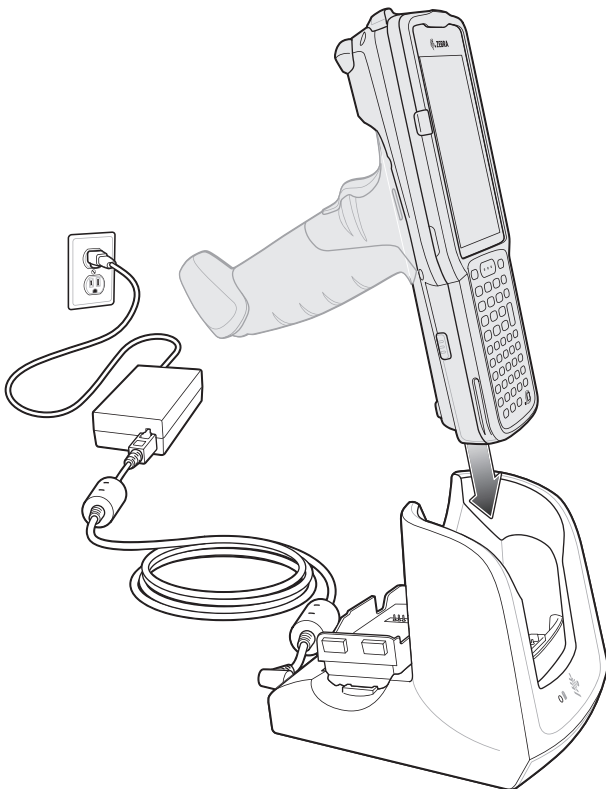
3. Insert the adapter into the MC32N0 cradle and adhere to the bottom of the cradle.

**Figure 34** Insert Adapter into Cradle and Adhere



4. Insert the MC33XX device into the MC32N0 cradle.

**Figure 35** Insert MC33XX device into MC32N0 Cradle



The MC33XX 2740 mAh PowerPrecision+ standard battery charges from 0% to 90% in less than 3 hours at room temperature.

The MC33XX 5200 mAh PowerPrecision+ extended battery charges from 0% to 90% in less than 5.5 hours at room temperature.

The MC32N0 2740 mAh PowerPrecision standard battery charges from 0% to 90% in less than 3 hours at room temperature.

The MC32N0 5200 mAh PowerPrecision extended battery charges from 0% to 90% in less than 5.5 hours at room temperature.

### **Charging Temperature**

Charge batteries in temperatures from 0 °C to 40 °C (32 °F to 104 °F). Charging is intelligently controlled by the MC33XX.

To accomplish this, for small periods of time, the MC33XX or cradle alternately enables and disables battery charging to keep the battery at acceptable temperatures. The MC33XX or cradle indicates when charging is disabled due to abnormal temperatures via its LED.



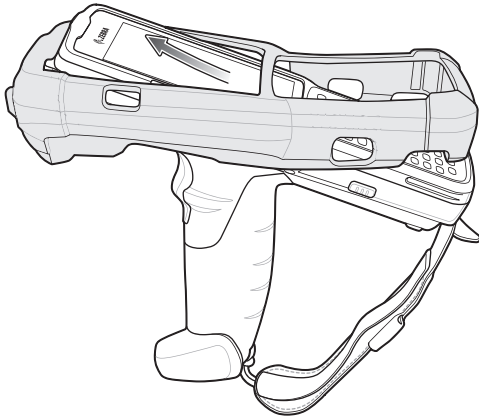
## MC33XX-G Rubber Boot

The rubber boot provides additional protection to the MC33XX-G.

To attach the rubber boot:

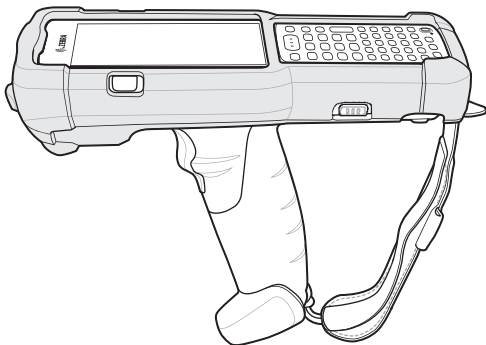
1. Slide the top of the MC33XX-G into the top of the rubber boot.

**Figure 36** Attach Top of Rubber Boot



2. Grasp the bottom of the rubber boot and place over the bottom of the MC33XX-G.

**Figure 37** Attach Bottom of Rubber Boot



**NOTE:** To function properly, remove the lower part of the rubber boot or the entire rubber boot before placing in a charging cradle.

---

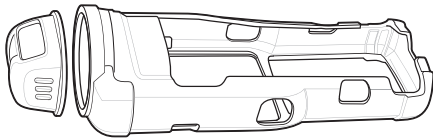
## MC33XX-R Rubber Boot

The rubber boot provides additional protection to the MC33XX-R. The rubber boot is comprised of two pieces; one for the mobile computer and one for the turret cup.

To attach the rubber boot:

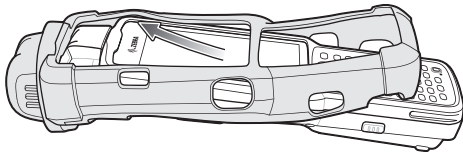
1. Insert the rubber boot for the turret cup into the rubber boot for the mobile computer, to form a single piece, if it is not already attached.

**Figure 38** Two Piece Rubber Boot



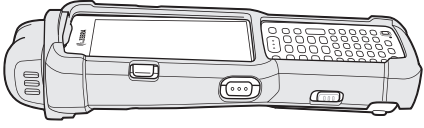
2. Slide the top of the MC33XX-R into the top of the rubber boot.

**Figure 39** Attach Top of Rubber Boot



3. Grasp the bottom of the rubber boot and place over the bottom of the MC33XX-R.

**Figure 40** Attach Bottom of Rubber Boot



**NOTE:** To function properly, remove the lower part of the rubber boot or the entire rubber boot before placing in a charging cradle.

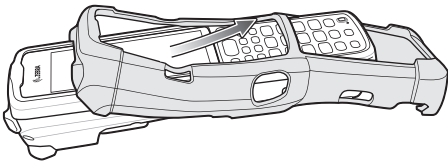
## MC33XX-S Rubber Boot

The rubber boot provides additional protection to the MC33XX-S.

To attach the rubber boot:

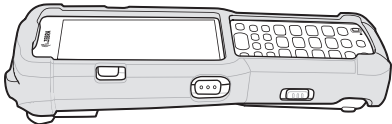
1. Slide the bottom of the MC33XX-S into the bottom of the rubber boot.

**Figure 41** Attach Bottom of Rubber Boot



2. Grasp the top of the rubber boot and place over the top of the MC33XX-S.

**Figure 42** Attach Top of Rubber Boot

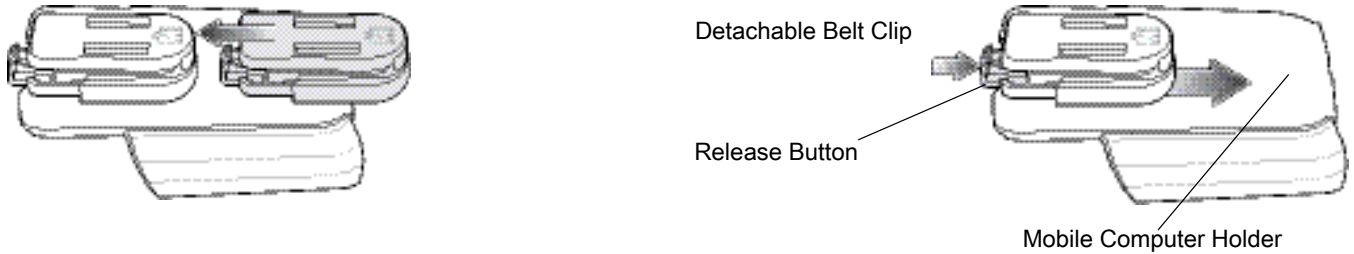


**NOTE:** To function properly, remove the lower part of the rubber boot or the entire rubber boot before placing in a charging cradle.

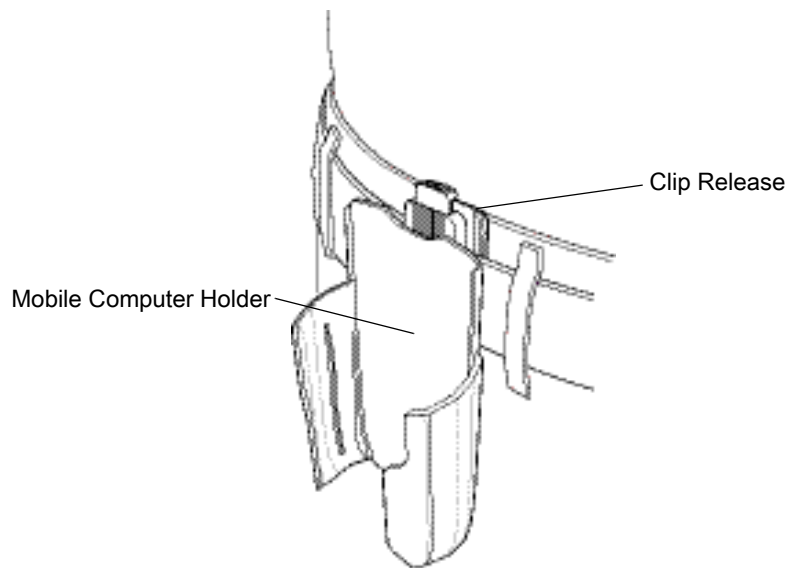
## Rigid Holster

The Rigid Holster provides a holder for the MC33XX-R/S. It consists of a mobile computer holder and a detachable belt clip. Press the release button to remove the detachable belt clip.

**Figure 43** Plastic Holster



**Figure 44** Attaching the Rigid Holster

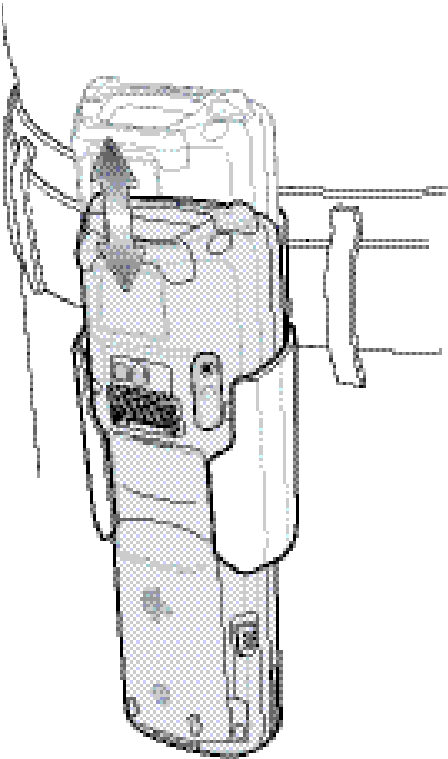


The Rigid Holster holds the mobile computer on a belt or waist band.

To insert the mobile computer, slide the mobile computer into the Rigid Holster with the screen facing the user.

To remove the mobile computer, press and lift to remove the mobile computer.

**Figure 45** Insert and Remove the Mobile Computer



---

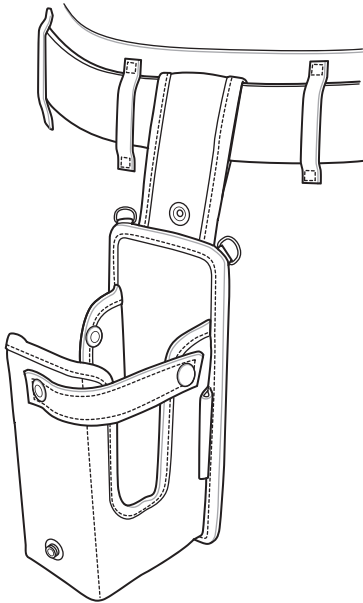
## MC33XX-G Fabric Holster

The fabric holster provides a soft holder for the mobile computer. It consists of a fabric mobile computer holder, a detachable shoulder strap and a belt strap. See figures below to attach the fabric holster to a belt and shoulder strap.

### Belt Strap

Attach the fabric holster to a belt or waist band.

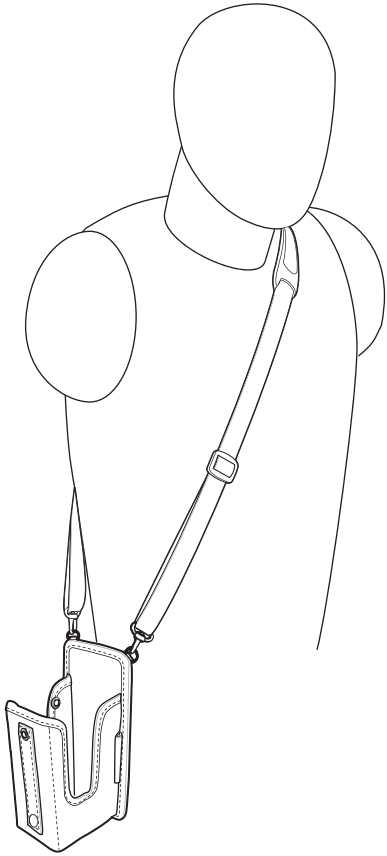
**Figure 46** Attach the Fabric Holster to a Belt



### Shoulder Strap

Attach the fabric holster to a shoulder strap.

**Figure 47** Attach the Fabric Holster to a Shoulder Strap

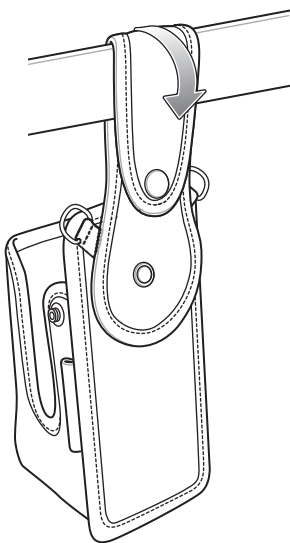


## Using the Belt Strap

The fabric holster holds the MC33XX-G on a belt or waist band.

1. Secure the belt strap over the belt or waistband and snap into place.

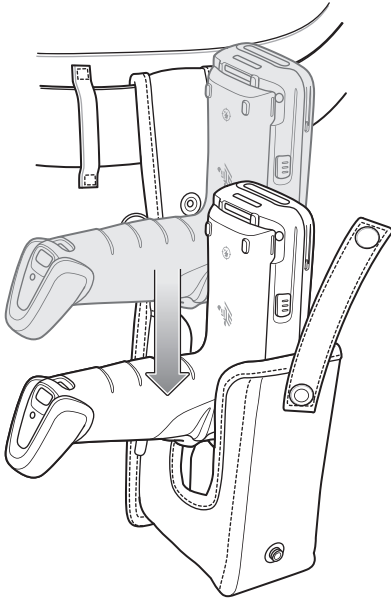
**Figure 48** Secure Belt Strap On Belt





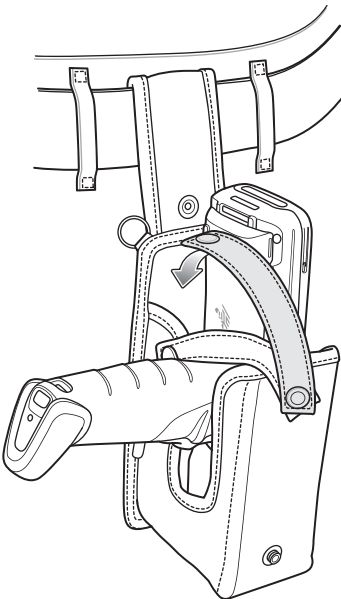
2. To insert the MC33XX-G, slide the mobile computer into the fabric holster with the screen facing the user.

**Figure 49** Insert MC33XX-G



3. Secure the MC33XX-G with the restraining strap and place over the MC33XX-G to secure in place.

**Figure 50** Secure with Strap

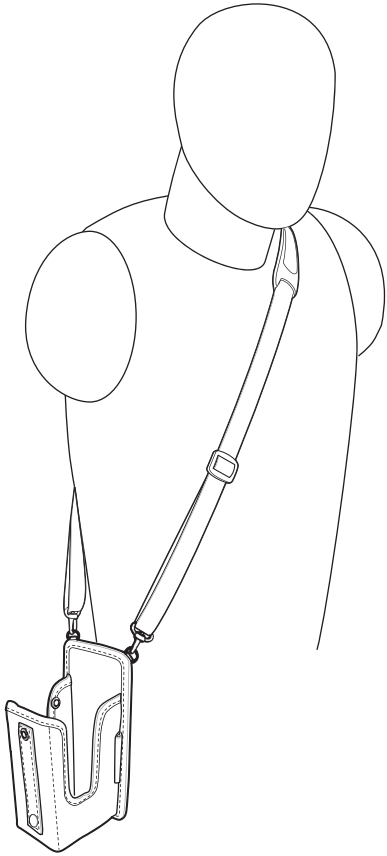


4. To remove the MC33XX-G, unsnap the restraining strap to release. Lift the MC33XX-G out of the fabric holster.

### Using the Shoulder Strap

1. Connect the clips on the shoulder strap to the rings on the fabric holster.
2. Place the shoulder strap over your head and rest on your shoulder.

**Figure 51** Shoulder Strap



3. Lift the strap and insert the MC33XX-G into the holster.
4. Secure the strap to hold the MC33XX-G in place.

---

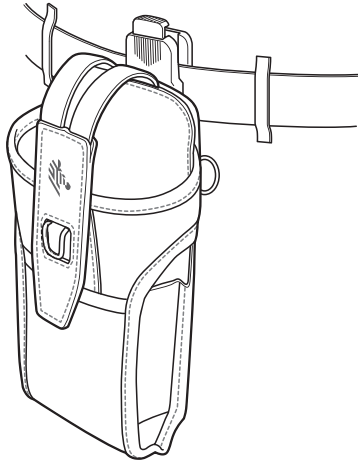
## MC33XX-R/S Fabric Holster

The fabric holster provides a soft holder for the mobile computer. It consists of a fabric mobile computer holder, a detachable shoulder strap and a belt clip. See figures below to attach the fabric holster to a belt and shoulder strap.

### Belt Clip

Attach the fabric holster to a belt or waist band.

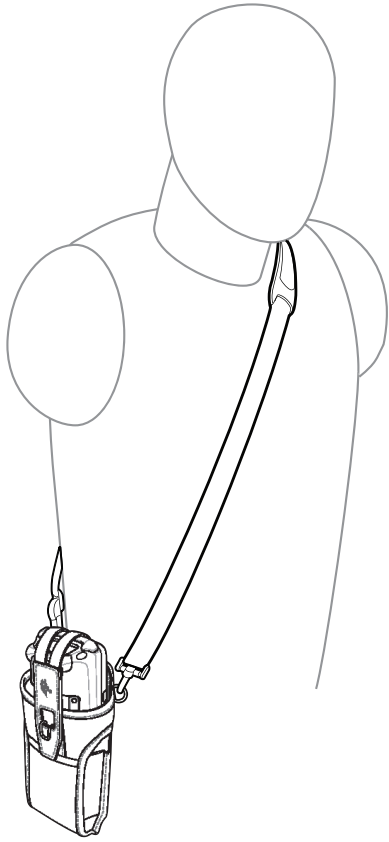
**Figure 52** Attach the Fabric Holster to a Belt



### Shoulder Strap

Attach the fabric holster to a shoulder strap.

**Figure 53** Attach the Fabric Holster to a Shoulder Strap

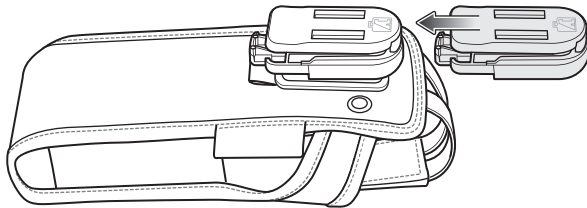


## Using the Belt Clip

The fabric holster holds the MC33XX-R/S on a belt or waist band.

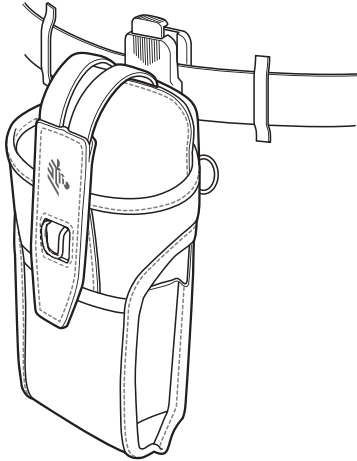
1. Secure the belt clip on the fabric holster, if it is not already attached.

**Figure 54** Secure Belt Clip On Fabric Holster



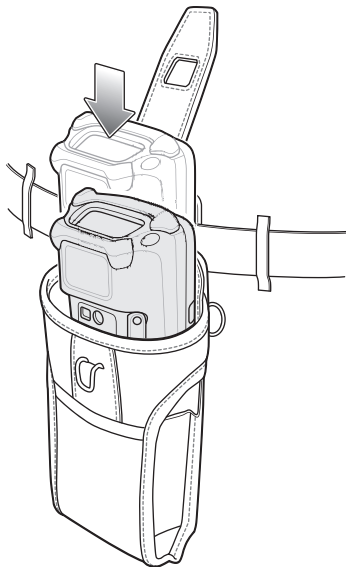
2. Secure the belt clip on the belt or waistband.

**Figure 55** Secure Belt Clip On Belt



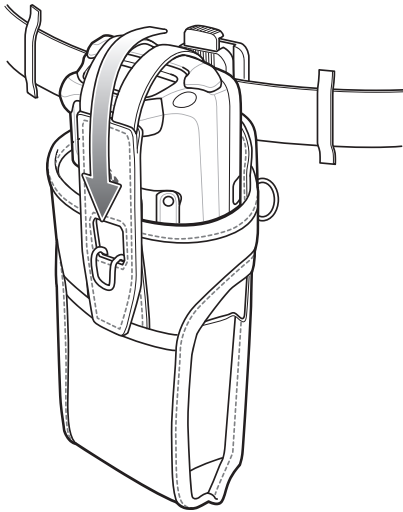
3. To insert the MC33XX-R/S, slide the mobile computer into the fabric holster with the screen facing the user.

**Figure 56** Insert MC33XX-R/S



4. Secure the MC33XX-R/S with the restraining strap and place over the MC33XX-R/S to secure in place.

**Figure 57** Secure with Strap

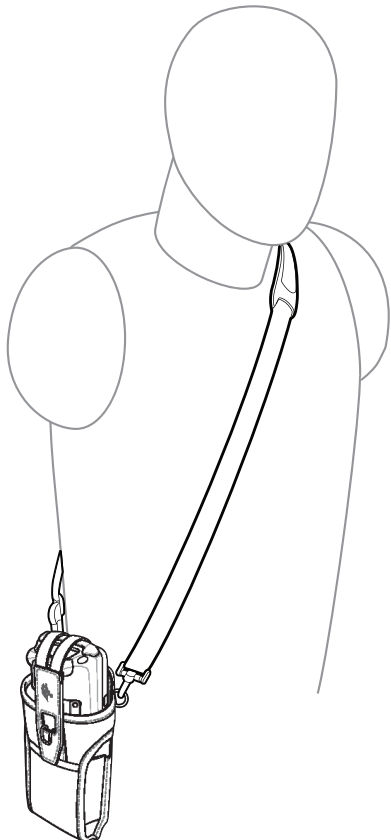


5. To remove the MC33XX-R/S, lift the restraining strap to release. Lift the MC33XX-R/S out of the fabric holster.

## Using the Shoulder Strap

1. Connect the clips on the shoulder strap to the rings on the fabric holster.
2. Place the shoulder strap over your head and rest on your shoulder.

**Figure 58** Shoulder Strap



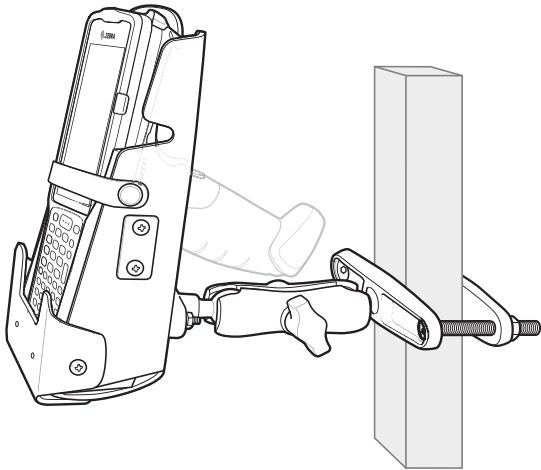
3. Lift the strap and insert the MC33XX-R/S into the holster.

4. Secure the strap to hold the MC33XX-R/S in place.

## Un-powered Forklift Mount

The Un-powered Forklift Mount allows the user to place the MC33XX in a holder while installed on a forklift. However, it does not provide charging or communication to the terminal. The Forklift Mount can be installed on a square surface or roll bar of a forklift and supports portrait (vertical) orientation.

**Figure 59** Forklift Mount



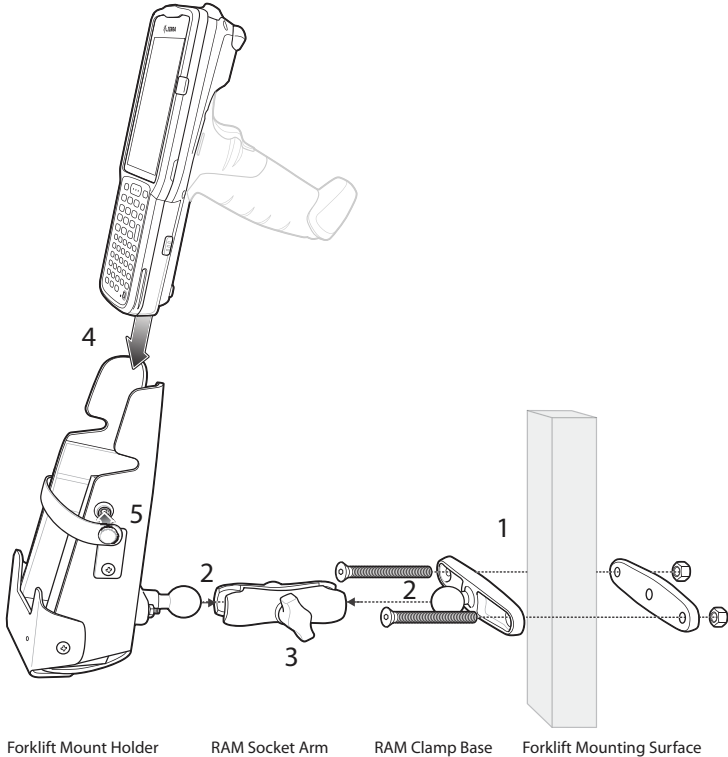
## Installation

To assemble the Forklift Mount:

1. Secure the RAM Clamp Base to the Forklift Mounting Surface.
2. Attach the RAM Socket Arm to the RAM Clamp Base and Forklift Mount Holder.
3. Turn the Socket Arm hand-screw clockwise until tight.
4. Insert the device in the Forklift Mount Holder.
5. Secure the device with the rubber strap and snap into place.



Figure 60 Forklift Mount Assembly

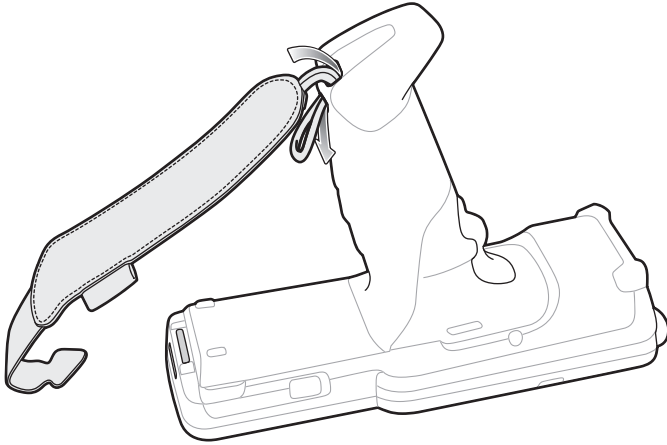


## Replacement Hand Strap for MC33XX-G

To install the hand strap:

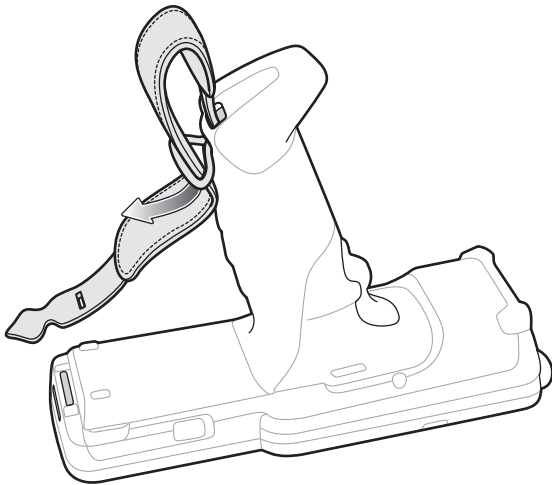
1. Thread the lanyard loop through the opening near the base of the trigger handle.

**Figure 61** Insert Loop Through Handle Slot



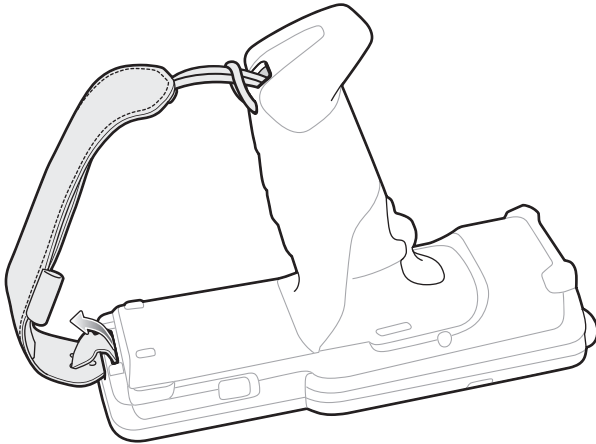
2. Insert the top end of the hand strap through the loop.

**Figure 62** Thread Hand Strap Through Loop



3. Thread the hand strap through the lanyard.
4. Pull the hand strap through the loop.
5. Thread the end of the hand strap with the tab through the slot on the bottom of the MC33XX-G.

**Figure 63** Thread Tab Through Slot



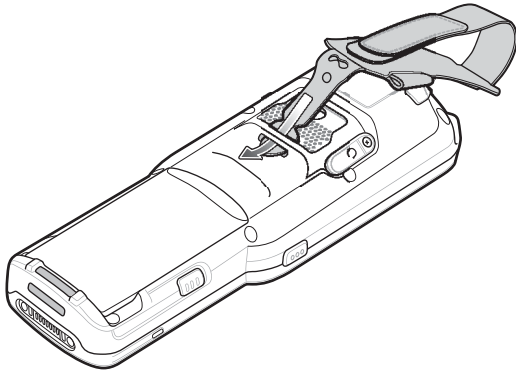
6. Slide the tab through the slit in the hand strap so that the tip of the tab is facing away from the MC33XX-G.

## Replacement Hand Strap for MC33XX-R/S

To install the hand strap:

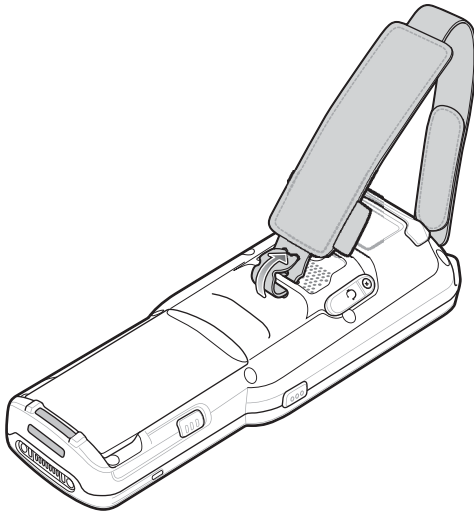
1. Thread the end of the hand strap with the tab through the slot toward the top of the MC33XX-R/S.

**Figure 64** Thread Tab Through Top Slot



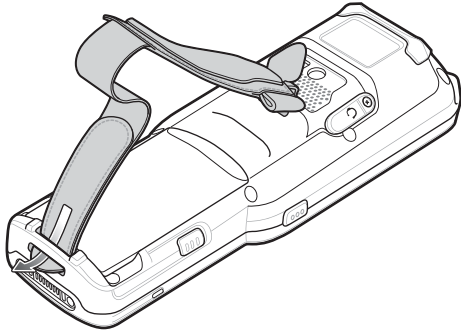
2. Slide the tab through the slit in the hand strap so that the tip of the tab is facing away from the MC33XX-R/S.

**Figure 65** Slide Tab Through Slit



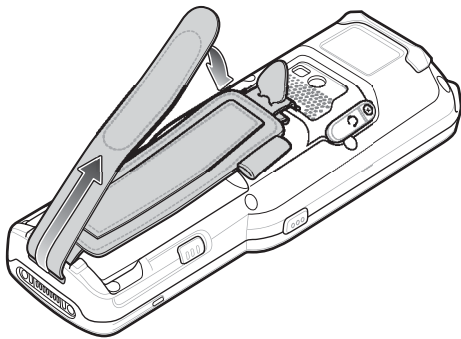
3. Thread the end of the hand strap with the velcro through the slot at the bottom of the MC33XX-R/S.

**Figure 66** Thread Velcro Through Bottom Slot



4. Pull the strap to the desired length and secure using the velcro.

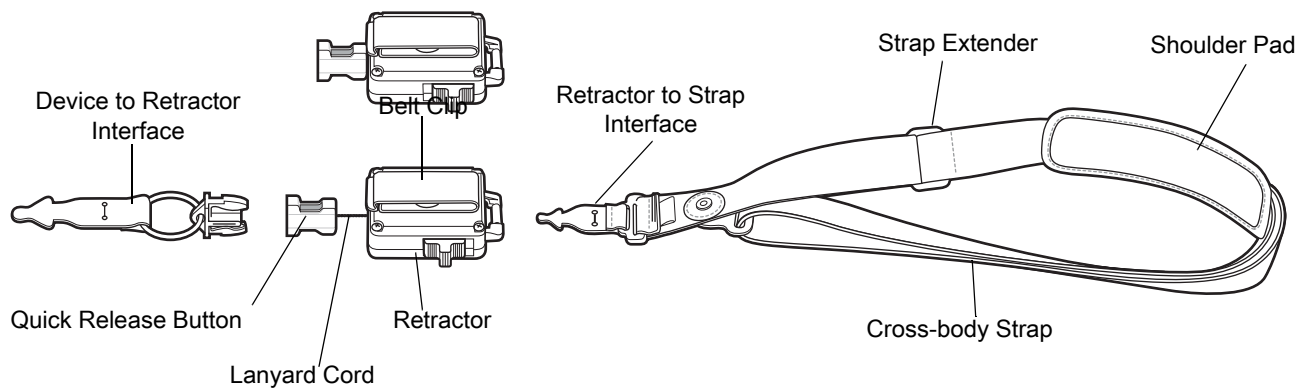
**Figure 67** Pull Strap and Secure Velcro



## Lanyard

The lanyard is an optional accessory for holding the MC33XX and is comprised of multiple pieces. The lanyard can be worn using the cross-body strap, or it can be worn on the belt, after removing the cross-body strap.

**Figure 68** Lanyard

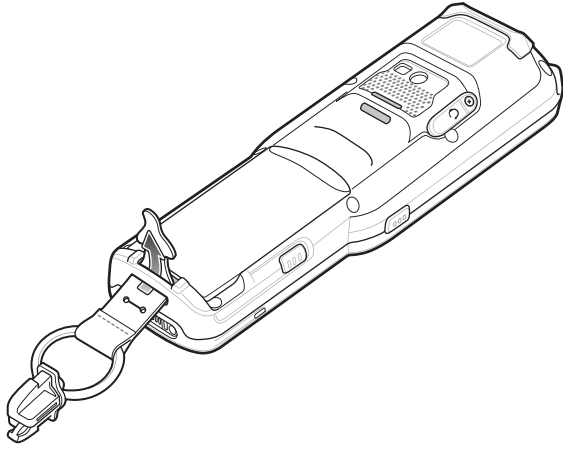


### Install Lanyard on MC33XX

To install the lanyard on the MC33XX:

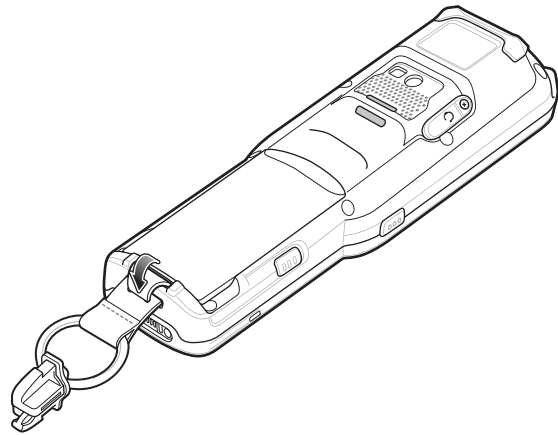
1. Thread the tab of the Device to Retractor Interface through the slot at the bottom of the MC33XX.

**Figure 69** Thread Tab Through Slot



2. Slide the tab through the slit in the Device to Retractor Interface.

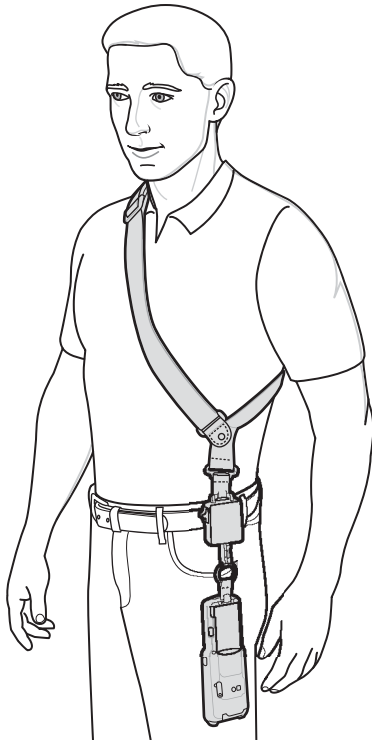
**Figure 70** Slide Tab Through Slit



## Using the Cross-body Strap

1. Place arm through strap and over the head to wear cross-body.

**Figure 71** Cross-body Lanyard



2. If needed, slide the Strap Extender to adjust the length of the Cross-body Strap to the desired length.
3. If needed, slide the Shoulder Pad along the Cross-body Strap to adjust the position of the Shoulder Pad for comfort.

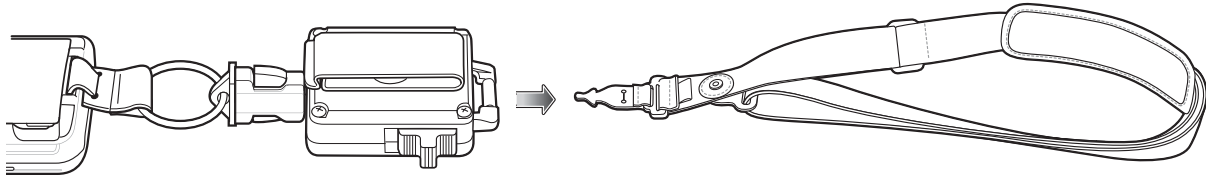
## Using the Belt Clip

To use the lanyard on a belt:

1. Detach the Cross-body Strap from the Retractor. To do this, unthread the tab of the Retractor to Strap Interface from the slot in the Retractor.

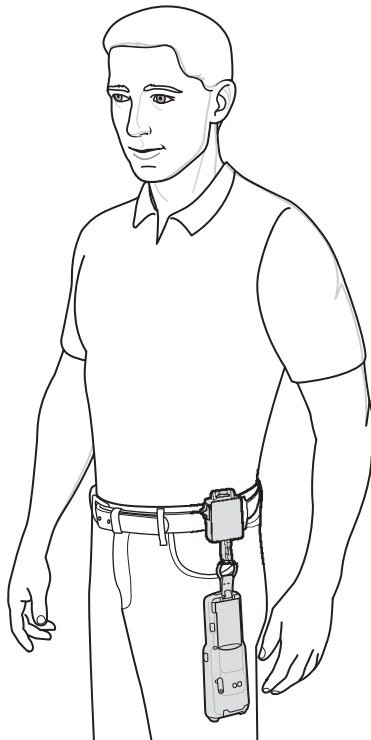


**Figure 72** Remove Cross-body Strap



2. Place the Belt Clip on a belt or waistband.

**Figure 73** Belt Clip Lanyard



## Charging the MC33XX with the Lanyard

To charge the MC33XX when using the lanyard:

1. Press the Quick Release Button on the Retractor.
2. Place the MC33XX in the charging cradle.

The Device to Retractor Interface remains attached to the MC33XX, while charging.

# USB Communication

---

## Introduction

This chapter provides information for transferring files between the MC33XX and a host computer.

---

## Connecting to a Host Computer via USB

Connect the MC33XX to a host computer using the USB Charge cable or the 1-Slot Charge cradle to transfer files between the MC33XX and the host computer.



**CAUTION:** When connecting the MC33XX to a host computer, follow the host computer's instructions for connecting and disconnecting USB devices, to avoid damaging or corrupting files.

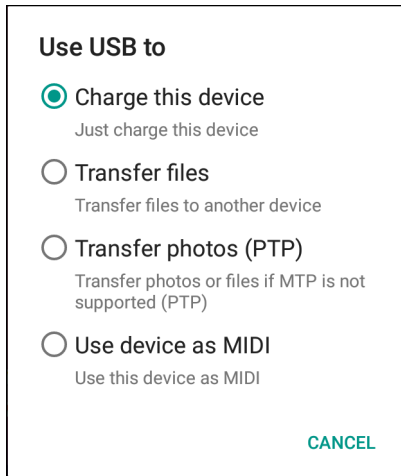
## Transferring Files using Media Transfer Protocol



**NOTE:** Use Media Transfer Protocol (MTP) to copy files between the MC33XX (internal memory or microSD card) and the host computer.

1. Connect the USB Charge cable to the MC33XX and then to the host computer or place the MC33XX into the 1-Slot Charge cradle.
2. Pull down the Notification panel and touch **USB charging this device**.

**Figure 74** Use USB Dialog Box



3. Touch **Transfer files**.
4. On the host computer, open a file explorer application.
5. Locate the MC33XX as a portable device.
6. Open the **SD card** or the **Internal storage** folder.
7. Copy files to and from the MC33XX or delete files as required.

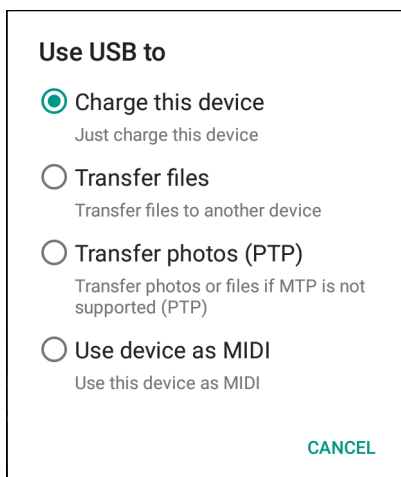
## Transferring Files using Photo Transfer Protocol



**NOTE:** Use Photo Transfer Protocol (PTP) to copy photos from either the microSD card or internal memory to the host computer.

1. Connect the USB Charge cable to the MC33XX and then to the host computer or place the MC33XX into the 1-Slot Charge cradle.
2. Pull down the Notification panel and touch **USB charging this device**.

**Figure 75** Use USB Dialog Box



3. Touch **Transfer photos (PTP)**.
4. On the host computer, open a file explorer application.
5. Open the **SD card** or the **Internal storage** folder.

6. Copy or delete photos as required.

---

### Disconnect from the Host Computer



**CAUTION:** Carefully follow the host computer's instructions to unmount the microSD card and disconnect USB devices correctly to avoid losing information.

To disconnect the MC33XX from the host computer:

1. On the host computer, unmount the device.
2. Remove the USB Charge cable from the MC33XX or remove the MC33XX from the 1-Slot Charge cradle.

# Datawedge Configuration

---

## Introduction

This chapter applies to DataWedge on Android devices. DataWedge is an application that reads data, processes the data and sends the data to an application.

---

## Basic Scanning

Scanning can be performed using an imager or laser scanner.

### Barcode Capture with Imager

To capture barcode data:

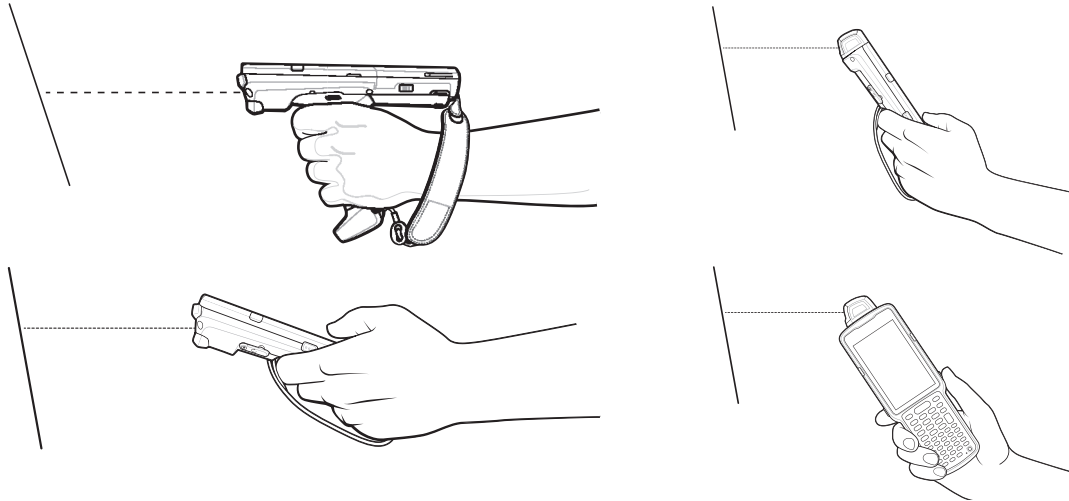
1. Ensure that an application is open on the device and a text field is in focus (text cursor in text field).
2. Point the top of the device at a barcode.
3. Press and hold the Scan button or Trigger.

The red laser aiming pattern turns on to assist in aiming.

4. Ensure the barcode is within the area formed by the cross-hairs in the aiming pattern. The aiming dot is used for increased visibility in bright lighting conditions.

The Scan LEDs light green and a beep sounds, by default, to indicate the barcode was decoded successfully. Note that when the device is in Pick List Mode, the device does not decode the barcode until the center of the crosshair touches the barcode.

**Figure 76** Data Capture



5. Release the scan button or Trigger.
6. The barcode content data appears in the text field.

## Barcode Capture with Laser Scanner

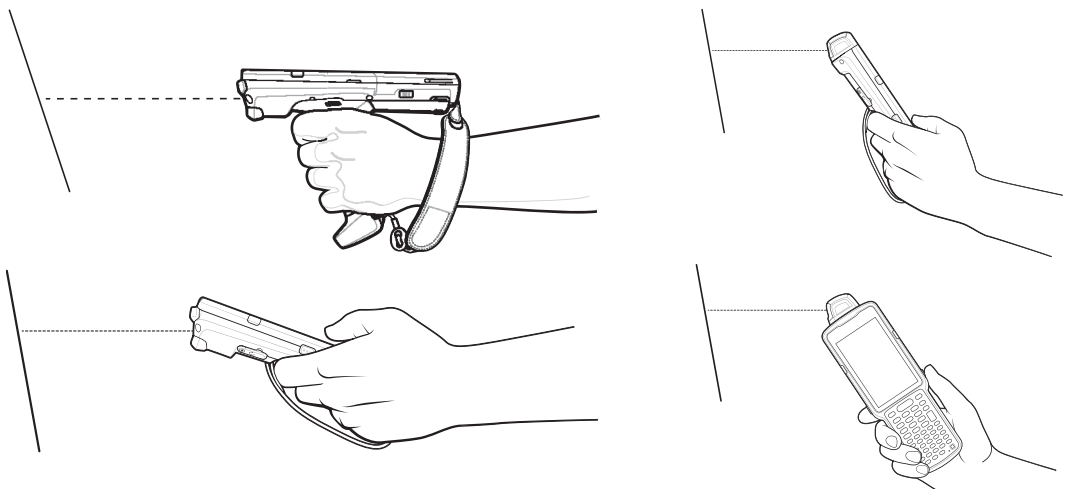
To capture barcode data:

1. Ensure that an application is open on the device and a text field is in focus (text cursor in text field).
2. Point the top of the device at a barcode.
3. Point the scan exit window at a bar code.
4. Press and hold the Scan button.

The red scan line turns on to assist in aiming. Ensure that the scan line crosses every bar and space of the barcode.

The Scan LEDs light green and a beep sounds, by default, to indicate the barcode was decoded successfully.

**Figure 77** Data Capture



5. Release the scan button.
6. The captured data appears in the text field.

## Profiles

DataWedge is based on profiles and plug-ins. A profile contains information on how DataWedge should behave with different applications.

Profile information consists of:

- Associated application
- Input plug-in configurations
- Output plug-in configurations
- Process plug-in configurations.

Using profiles, each application can have a specific DataWedge configuration. For example, each user application can have a profile which outputs scanned data in the required format when that application comes to the foreground. DataWedge can be configured to process the same set of captured data differently based on the requirements of each application.

DataWedge includes the following pre-configured profiles which support specific built-in applications:

- Visible profiles:
  - **Profile0** - created automatically the first time DataWedge runs. Generic profile used when there are no user created profiles associated with an application.
  - **Launcher** - enables scanning when the Launcher is in foreground.
  - **DWDemo** - provides support for the DWDemo application.
- Hidden profiles (not shown to the device):
  - **RD Client** - provides support for MSP.
  - **MSP Agent** - provides support for MSP.
  - **MspUserAttribute** - provides support for MSP.
  - **Camera** - disables scanning when the default camera application is in foreground.
  - **RhoElements** - disables scanning when RhoElements is in foreground.
  - **StageNow** - provides support for the StageNow application.

Some Zebra applications are capable of capturing data by scanning. DataWedge is pre-loaded with private and hidden profiles for this purpose. There is no option to modify these private profiles.

## Profile0

**Profile0** can be edited but cannot be associated with an application. That is, **DataWedge** allows manipulation of plug-in settings for **Profile0** but it does not allow assignment of a foreground application. This configuration allows **DataWedge** to send output data to any foreground application other than applications associated with user-defined profiles when **Profile0** is enabled.

**Profile0** can be disabled to allow **DataWedge** to only send output data to those applications which are associated in user-defined profiles. For example, create a profile associating a specific application, disable **Profile0** and then scan. **DataWedge** only sends data to the application specified in the user-created profile. This adds additional security to **DataWedge** enabling the sending of data only to specified applications.

---

## Plug-ins

A plug-in is a software module utilized in DataWedge to extend its functionality to encompass technologies such as barcode scanning. The plug-ins can be categorized into three types based on their operations:

- Input Plug-ins
- Output Plug-ins
- Process Plug-ins.

### Input Plug-ins

An Input Plug-in supports an input device, such as a barcode scanner contained in, or attached to the device. **DataWedge** contains base plug-ins for these input devices.

- **Barcode Scanner Input Plug-in** – The Barcode Scanner Input Plug-in is responsible for reading data from the integrated barcode scanner and supports different types of barcode readers including laser, imager and internal camera. Raw data read from the barcode scanner can be processed or formatted using Process Plug-ins as required. **DataWedge** has built-in feedback functionality for the barcode scanner to issue user alerts. The feedback settings can be configured according to user requirement.

### Process Plug-ins

Process Plug-ins are used in **DataWedge** to manipulate the received data according to the requirement, before sending to the foreground application via the Output Plug-in.

- **Basic Data Formatting Process Plug-in** – The Basic Data Formatting Plug-in allows **DataWedge** to add a prefix and/or a suffix to the captured data before passing it to an Output Plug-in.
- **Advanced Data Formatting Process Plug-in** – The Advanced Data Formatting Plug-in allows **DataWedge** to apply rules (actions to be performed based on defined criteria) to the data received via an input plug-in before passing it to an Output Plug-in.


### Output Plug-ins

Output Plug-ins are responsible for sending the data from Input Plug-ins to a foreground application on the device.

- **Keystroke Output Plug-in** – The Keystroke Output Plug-in collects and sends data received from the Input Plug-in to the foreground applications by emulating keystrokes.
- **Intent Output Plug-in** – The Intent Output Plug-in collects and sends data received from the Input Plug-ins to foreground applications using the Android Intent mechanism.
- **IP Output Plug-in** – The IP Output Plug-in collects and sends data received from the Input Plug-ins to a host computer via a network connection. Captured data can be sent over an IP network to a specified IP address and port using either TCP or UDP transport protocols.

---

## Profiles Screen

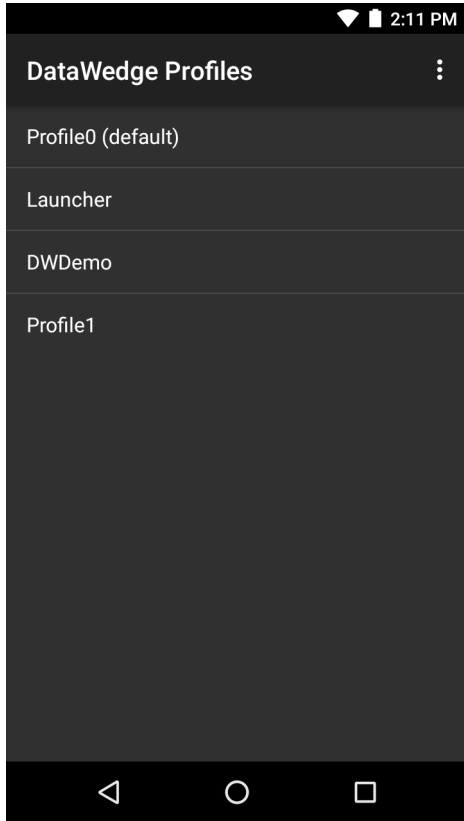
To launch DataWedge, swipe up from the bottom of the screen and touch . By default, three profiles appear:

- **Profile0**
- **Launcher**
- **DWDemo.**



Profile0 is the default profile and is used when no other profile can be applied.

**Figure 78** DataWedge Profiles Screen



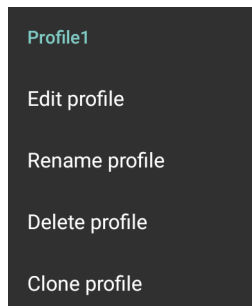
Profile names are color coded. Enabled profiles are white and disabled profiles are gray.

To configure a profile touch the profile name.

## Profile Context Menu


Touch and hold a profile to open a context menu that allows additional actions to be performed on the selected profile.

**Figure 79** Profile Context Menu

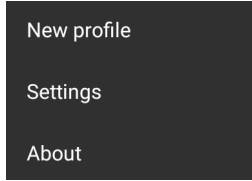


The profile context menu allows the profile to be edited (same as just tapping on a profile), renamed or deleted.

## Options Menu



Touch  to open the options menu.

**Figure 80** DataWedge Options Menu



The menu provides options to create a new profile, access to general DataWedge settings and DataWedge version information.



## Disabling DataWedge

1. Swipe up from the bottom of the screen and touch .
2. Touch .
3. Touch **Settings**.
4. Touch **DataWedge enabled**.

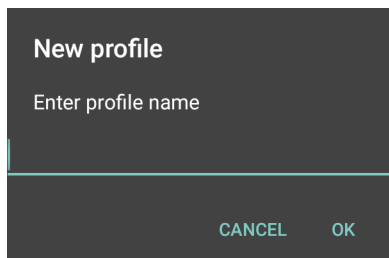
The blue check disappears from the checkbox indicating that DataWedge is disabled.

## Creating a New Profile

To create a new profile:

1. Swipe up from the bottom of the screen and touch .
2. Touch .
3. Touch **New profile**.
4. In the **New profile** dialog box, enter a name for the new profile. It is recommended that profile names be unique and made up of only alpha-numeric characters (A-Z, a-z, 0-9).

**Figure 81** New Profile Name Dialog Box

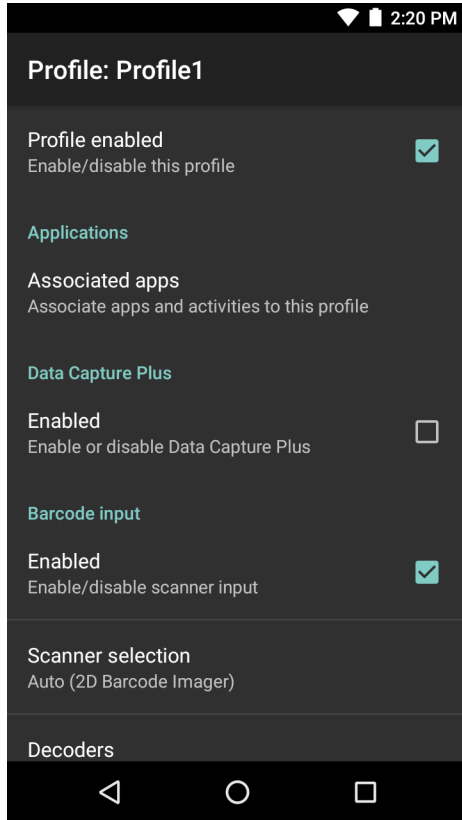


5. Touch **OK**.  
The new profile name appears in the **DataWedge profile** screen.

## Profile Configuration

To configure the Profile0 or a user-created profile, touch the profile name.

**Figure 82** Profile Configuration Screen



The configuration screen lists the following sections:

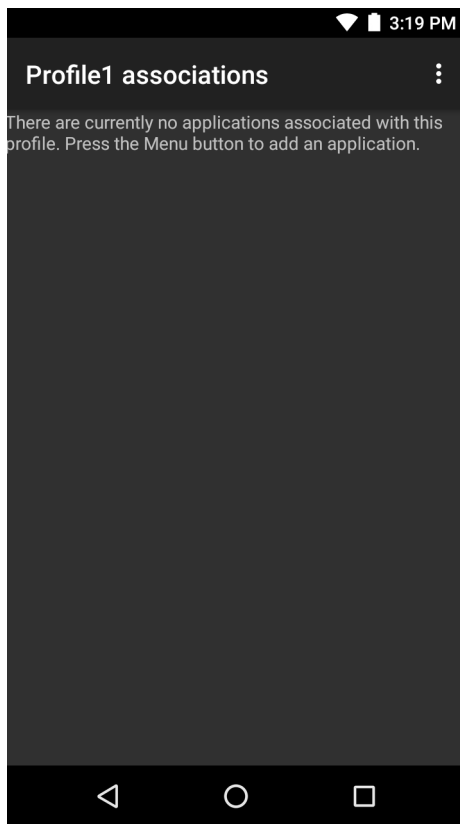
- Profile enabled
- Applications
- Data Capture Plus (DCP)
- Barcode Input
- SimulScan Input
- Keystroke output
- Intent Output
- IP Output.

## Associating Applications

Use Applications option to associate applications with this profile. User created profiles should be associated with one or more applications and its activities.

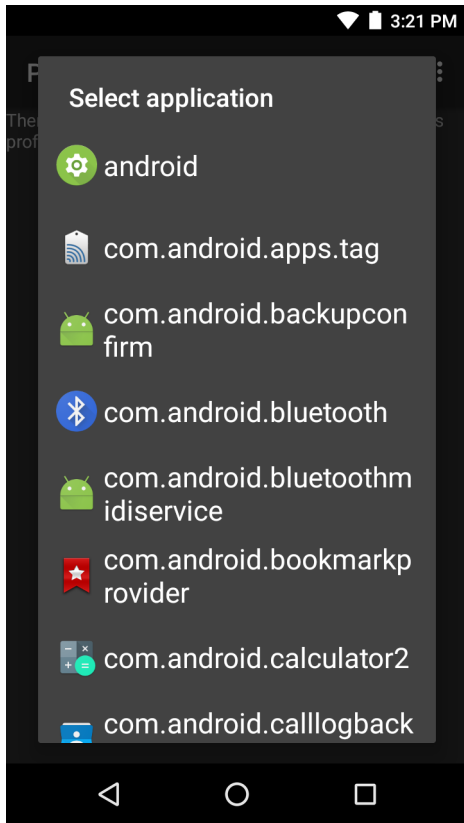
1. Touch **Associated apps**. A list of applications/activities associated with the profile displays. Initially the list does not contain any applications/activities.

**Figure 83** Associated Apps Screen



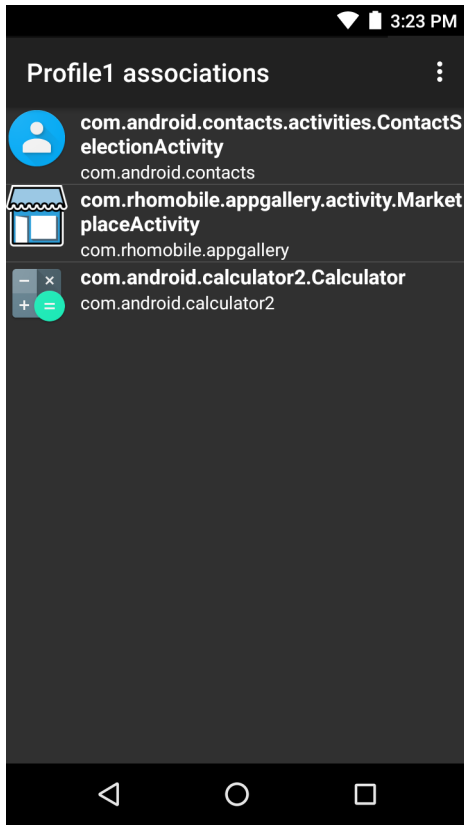
2. Touch  .
3. Touch **New app/activity**.

**Figure 84** Select Application Menu



4. In the **Select application** screen, select the desired application from the list.
5. In the **Select activity** menu, selecting the activity adds that application/activity combination to the associated application list for that profile. Selecting \* as the activity results in all activities within that application being associated to the profile. During operation, DataWedge tries to match the specific application/activity combinations with the foreground application/activity before trying to match the general application/\* combinations.
6. Touch .

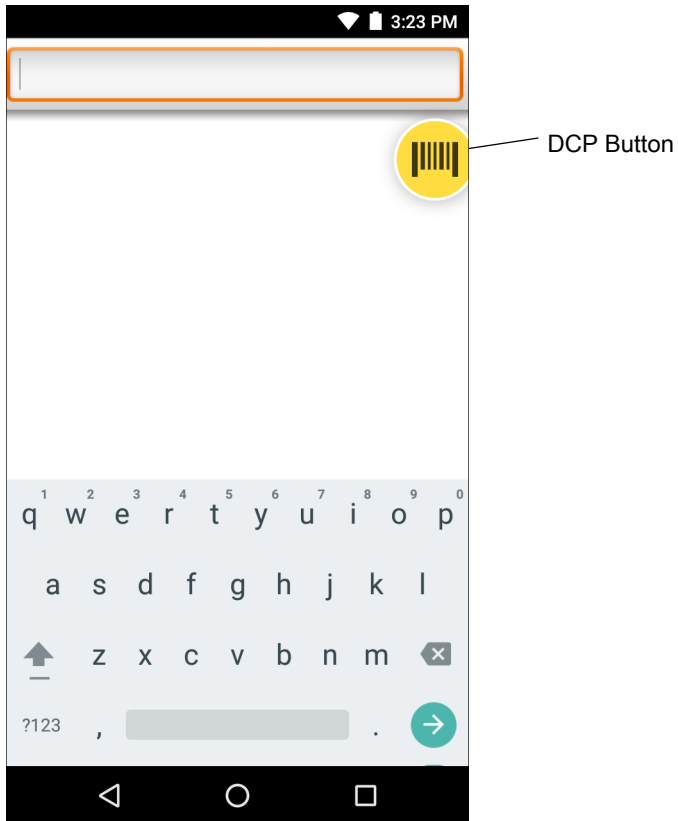
**Figure 85** Selected Application/Activity



## Data Capture Plus

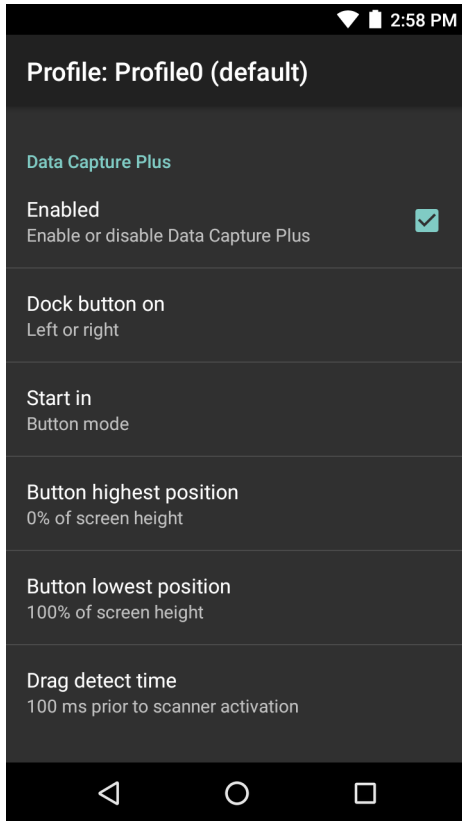
Data Capture Plus (DCP) is a DataWedge feature that enables the user to initiate data capture by touching a designated part of the screen. A variable screen overlay acts like a scan button.

**Figure 86** Minimized Data Capture Panel



The DataWedge profile configuration screen allows the user to configure how the DCP appears on the screen once the particular profile is enabled. The DCP is hidden by default. Enabling DCP option displays seven additional configuration parameters.

**Figure 87** Data Capture Panel Settings



- **Enable** - Select to enable Data Capture Plus (default - disabled).
- **Dock button on** - Select position of the button.
  - **Left or right** - Allows user to place the button on either the right or left edge of the screen.
  - **Left only** - Places the button on left edge of the screen.
  - **Right only** - Places the button on the right edge of the screen.
- **Start in** - Select the initial DCP state.
  - **Fullscreen mode** - DCP covers the whole screen.
  - **Button mode** - DCP displays as a circular button on the screen and can be switched to fullscreen mode.
  - **Button only mode** - DCP displays as a circular button on the screen and cannot be switched to fullscreen mode.
- **Button highest position** - Select the top of the range the user is allowed to move the DCP, given as a percent of the screen height (default - 0).
- **Button lowest position** - Select the bottom of the range the user is allowed to move the DCP, given as a percent of the screen height (default - 100).
- **Drag detect time** - Select the time in milliseconds that the scanner waits before activating scanner. This allows the user to drag the button without initiating scanner (default - 100 ms, maximum 1000 ms).

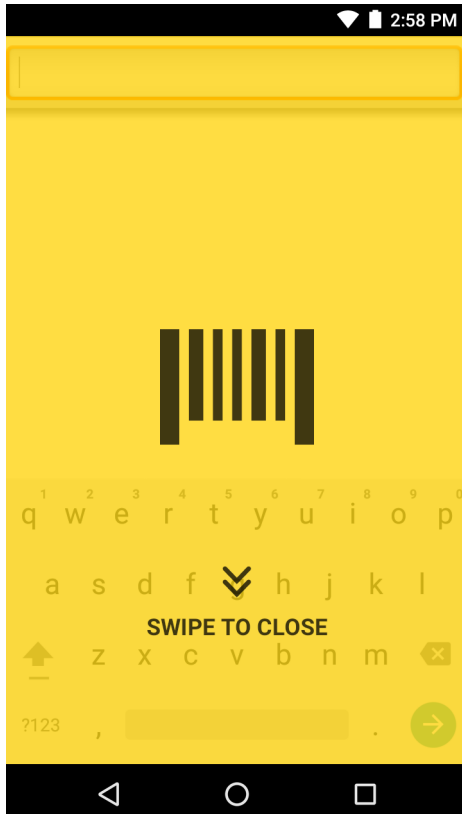


**NOTE:** The DCP does not appear if the scanner is disabled in the profile even though the **Enabled** option is set.



In Button mode, the user can place DCP in full screen mode by dragging the button over **Fullscreen mode**. The overlay covers the screen.

**Figure 88** Maximized DCP



Swipe down to return to button mode.

## Barcode Input

Use the **Barcode Input** options to configure the Barcode Scanner Input Plug-in for the profile.

### Enabled

Enables or disables this plug-in. A check in the checkbox indicates that the plug-in is enabled.

### Scanner Selection

Configures which scanning device to use for barcode data capture when the profile is active.

- **Auto** - The software automatically determines the best scanning device.
- **Serial SSI Scanner** - Scanning is performed using the 1D imager (SE965).
- **2D Barcode Imager** - Scanning is performed using the 2D Imager. (SE4750-SR, SE4850-ER)
- **Bluetooth Scanner** - Scanning is performed using the option Bluetooth scanner.
- **RS6000 Bluetooth Scanner** - Scanning is performed using the RS6000 Bluetooth scanner.
- **DS3678 Bluetooth Scanner** - Scanning is performed using the DS3678 Bluetooth scanner.

## Decoders

Configures which barcode decoders are enabled or disabled. For best performance disable all unnecessary decoders.

Touch **Decoders**. The **Barcode input** screen appears. A check in the checkbox indicates that the decoder is enabled. By default the most commonly used decoders are enabled (shown below with an asterisk). The supported decoders are:




**NOTE:** DataWedge supports the decoders listed below but not all are validated on this device.

**Table 10** Supported Decoders

Decoders	Internal Imager 965	Internal Imager SE4750-SR & SE4850-ER	RS507/RS507X	RS6000	DS3678
Australian Postal	Not Supported	Disabled	Disabled	Disabled	Disabled
Aztec	Not Supported	Enabled	Enabled	Enabled	Enabled
Canadian Postal	Not Supported	Disabled	Not supported	Disabled	Not Supported
Chinese 2 of 5	Disabled	Disabled	Disabled	Disabled	Disabled
Codabar	Enabled	Enabled	Enabled	Enabled	Enabled
Code 11	Disabled	Disabled	Disabled	Disabled	Disabled
Code 128	Enabled	Enabled	Enabled	Enabled	Enabled
Code 39	Enabled	Enabled	Enabled	Enabled	Enabled
Code 93	Disabled	Disabled	Disabled	Disabled	Disabled
Composite AB	Not Supported	Disabled	Disabled	Disabled	Disabled
Composite C	Not Supported	Disabled	Disabled	Disabled	Disabled
Discrete 2 of 5	Disabled	Disabled	Disabled	Disabled	Disabled
Datamatrix	Not Supported	Enabled	Enabled	Enabled	Enabled
Dutch Postal	Not Supported	Disabled	Disabled	Disabled	Disabled
EAN13	Enabled	Enabled	Enabled	Enabled	Enabled
EAN8	Enabled	Enabled	Enabled	Enabled	Enabled
GS1 DataBar	Enabled	Enabled	Enabled	Enabled	Enabled
GS1 DataBar Expanded	Enabled	Enabled	Enabled	Enabled	Enabled
GS1 DataBar Limited	Disabled	Disabled	Disabled	Disabled	Disabled
HAN XIN	Not Supported	Disabled	Not supported	Disabled	Disabled

**Table 10** Supported Decoders (Continued)

Decoders	Internal Imager 965	Internal Imager SE4750-SR & SE4850-ER	RS507/RS507X	RS6000	DS3678
Interleaved 2 of 5	Disabled	Disabled	Disabled	Disabled	Disabled
Japanese Postal	Not Supported	Disabled	Disabled	Disabled	Disabled
Korean 3 of 5	Disabled	Disabled	Disabled	Disabled	Disabled
MAIL MARK	Not Supported	Enabled	Not supported	Enabled	Enabled
Matrix 2 of 5	Disabled	Disabled	Disabled	Disabled	Disabled
Maxicode	Not Supported	Enabled	Enabled	Enabled	Enabled
MicroPDF	Not Supported	Disabled	Disabled	Disabled	Disabled
MicroQR	Not Supported	Disabled	Disabled	Disabled	Disabled
MSI	Disabled	Disabled	Disabled	Disabled	Disabled
PDF417	Not Supported	Enabled	Enabled	Enabled	Enabled
QR Code	Not Supported	Enabled	Enabled	Enabled	Enabled
Decoder Signature	Not Supported	Disabled	Disabled	Disabled	Not Supported
TLC 39	Disabled	Disabled	Disabled	Disabled	Disabled
Trioptic 39	Disabled	Disabled	Disabled	Disabled	Disabled
UK Postal	Not Supported	Disabled	Disabled	Disabled	Disabled
UPCA	Enabled	Enabled	Enabled	Enabled	Enabled
UPCE0	Enabled	Enabled	Enabled	Enabled	Enabled
UPCE1	Disabled	Disabled	Disabled	Disabled	Disabled
US4state	Not Supported	Disabled	Disabled	Disabled	Disabled
US4state FICS	Not Supported	Disabled	Disabled	Disabled	Disabled
US Planet	Not Supported	Disabled	Disabled	Disabled	Disabled
US Postnet	Not Supported	Disabled	Disabled	Disabled	Disabled

Touch  to return to the previous screen.

## Decoder Params

Use **Decode Params** to configure individual decoder parameters.

## Codabar

- **CLSI Editing** - Enable this parameter to strip the start and stop characters and insert a space after the first, fifth, and tenth characters of a 14-character Codabar symbol. Enable this feature if the host system requires this data format (default - disabled).
- **Length1** - Use to set decode lengths (default - 6). See [Decode Lengths on page 113](#) for more information.
- **Length2** - Use to set decode lengths (default - 55). See [Decode Lengths on page 113](#) for more information.
- **NOTIS Editing** - Enable this parameter to strip the start and stop characters from a decoded Codabar symbol. Enable this feature if the host system requires this data format (default - disabled).
- **Redundancy** - Sets the reader to read the barcode twice before accepting data. A check in the checkbox indicates that redundancy is enabled (default - enabled).

## Code 11

- **Length1** - Use to set decode lengths (default - 4). See [Decode Lengths on page 113](#) for more information.
- **Length2** - Use to set decode lengths (default - 55). See [Decode Lengths on page 113](#) for more information.
- **Redundancy** - Sets the reader to read the barcode twice before accepting data. A check in the checkbox indicates that redundancy is enabled (default - enabled).
- **Report Check Digit** - Transmit Code 11 data with or without the check digit. A check in the checkbox indicates to send Code 11 data with check digit (default - disabled).
- **Verify Check Digit** - Check the integrity of all Code 11 symbols to verify that the data complies with the specified check digit algorithm. This selects the check digit mechanism for the decoded Code 11 barcode.
  - **No Check Digit** - Do not verify check digit.
  - **1 Check Digit** - Barcode contains one check digit (default).
  - **2 Check Digits** - Barcode contains two check digits.

## Code128

- **Code128 Reduced Quiet Zone** - Enables decoding of margin-less Code 128 barcodes. (SE4750-SR, SE4850-ER, RS6000, and DS3678).
- **Ignore Code128 FNC4** - When enabled, and a Code 128 barcode has an embedded FNC4 character, it will be removed from the data and the following characters will not be changed. When the feature is disabled, the FNC4 character will not be transmitted but the following character will have 128 added to it. (SE4750-SR, SE4850-ER, RS6000, and DS3678).
- **Check ISBT Table** - The ISBT specification includes a table that lists several types of ISBT barcodes that are commonly used in pairs. If ISBT128 Concat Mode is set, enable Check ISBT Table to concatenate only those pairs found in this table. Other types of ISBT codes are not concatenated. A check in the checkbox indicates that redundancy is enabled (default - disabled).
- **Enable GS1-128** - Set the GS1 128 subtype. A check in the checkbox indicates that the option is enabled (default - enabled).
- **Enable ISBT128** - Set the ISBT128 subtype. A check in the checkbox indicates that the option is enabled (default - enabled).
- **Enable Plain Code128** - Set the Plain Code128 subtype. Enables other (non-EAN or ISBT) Code 128 subtypes. A check in the checkbox indicates that the option is enabled (default - enabled).

- **ISBT128 Concatenation Mode** - Select an option for concatenating pairs of ISBT code types:
  - **Concat Mode Never** - Do not concatenate pairs of ISBT codes encountered (default).
  - **Concat Mode Always** - There must be two ISBT codes in order to decode and perform concatenation. Does not decode single ISBT symbols.
  - **Concat Mode Auto** - Decodes and concatenates pairs of ISBT codes immediately. If only a single ISBT symbol is present, the device must decode the symbol the number of times set via DataWedge Configuration 4 - 11 Redundancy - Code128 before transmitting its data to confirm that there is no additional ISBT symbol.
- **Length1** - Use to set decode lengths (default - 0). See [Decode Lengths on page 113](#) for more information.
- **Length2** - Use to set decode lengths (default - 55). See [Decode Lengths on page 113](#) for more information.
- **Redundancy** - Sets the reader to read the barcode twice before accepting data. A check in the checkbox indicates that redundancy is enabled (default - disabled).
- **Security Level** - The scanner offers four levels of decode security for Code 128 barcodes. Select increasing levels of security for decreasing levels of barcode quality. There is an inverse relationship between security and scanner aggressiveness, so choose only that level of security necessary for any given application.
  - **Security Level 0** - This setting allows the scanner to operate in its most aggressive state, while providing sufficient security in decoding most "in-spec" barcodes.
  - **Security Level 1** - This setting eliminates most misdecodes (default).
  - **Security Level 2** - Select this option if Security level 1 fails to eliminate misdecodes.
  - **Security Level 3** - If Security Level 2 is selected and misdecodes still occur, select this security level. Be advised, selecting this option is an extreme measure against mis-decoding severely out of spec barcodes. Selecting this level of security significantly impairs the decoding ability of the scanner. If this level of security is needed, try to improve the quality of the barcodes.

### Code39

- **Code39 Reduced Quiet Zone** - Enables decoding of margin-less Code 39 barcodes. (SE4750-SR, SE4850-ER, RS6000, and DS3678).
- **Convert Code39 To Code32** - Code 32 is a variant of Code 39 used by the Italian pharmaceutical industry. Scan the appropriate barcode below to enable or disable converting Code 39 to Code 32 (default - disabled).
- **Full ASCII** - Code 39 Full ASCII is a variant of Code 39 that pairs characters to encode the full ASCII character set. To enable or disable Code 39 Full ASCII (default - disabled),
- **Length1** - Use to set decode lengths (default - 0). See [Decode Lengths on page 113](#) for more information.
- **Length2** - Use to set decode lengths 4 (default - 55). See [Decode Lengths on page 113](#) for more information.
- **Redundancy** - Sets the reader to read the barcode twice before accepting data. A check in the checkbox indicates that redundancy is enabled (default - disabled).
- **Report Check Digit** - Transmit Code 39 data with or without the check digit. A check in the checkbox indicates to send Code 39 data with check digit (default - disabled).
- **Report Code32 Prefix** - Scan the appropriate barcode to enable or disable adding the prefix character "A" to all Code 32 barcodes (default - disabled).

- **Security Level** - Options: **Security level 0**, **Security Level 1**, **Security Level 2** and **Security Level 3** (default - Security level 1).
  - **Security Level 0** - This setting allows the scanner to operate in its most aggressive state, while providing sufficient security in decoding most “in-spec” barcodes.
  - **Security Level 1** - This setting eliminates most misdecodes (default).
  - **Security Level 2** - Select this option if Security level 1 fails to eliminate misdecodes.
  - **Security Level 3** - If Security Level 2 is selected and misdecodes still occur, select this security level. Be advised, selecting this option is an extreme measure against mis-decoding severely out of spec barcodes. Selecting this level of security significantly impairs the decoding ability of the scanner. If this level of security is needed, try to improve the quality of the barcodes.
- **Verify Check Digit** - Enable this feature to check the integrity of all Code 39 symbols to verify that the data complies with a specified check digit algorithm. The digital scanner decodes only those Code 39 symbols that include a modulo 43 check digit. Enable this feature only if the Code 39 symbols contain a modulo 43 check digit (default - disabled).

### Code93

- **Length1** - Use to set decode lengths (default - 0). See [Decode Lengths on page 113](#) for more information.
- **Length2** - Use to set decode lengths (default - 55). See [Decode Lengths on page 113](#) for more information.
- **Redundancy** - Sets the reader to read the barcode twice before accepting data. A check in the checkbox indicates that redundancy is enabled (default - disabled).

### Composite AB

- **UCC Link Mode** (SE4750-SR, SE4850-ER, RS507/RS507X, RS6000, and DS3678)
  - **Link Flag ignored** - 1D component is transmitted regardless of whether a 2D component is detected.
  - **Always Linked** - 1D and the 2D components are transmitted. If 2D is not present, the 1D component is not transmitted.
  - **Auto Discriminate** - the digital scanner determines if there is a 2D portion, then transmits the 1D component, as well as the 2D portion if present. (default).

### Discrete 2 of 5

- **Length1** - Use to set decode lengths (default - 0). See [Decode Lengths on page 113](#) for more information.
- **Length2** - Use to set decode lengths (default - 14). See [Decode Lengths on page 113](#) for more information.
- **Redundancy** - Sets the reader to read the barcode twice before accepting data. A check in the checkbox indicates that redundancy is enabled (default - enabled).

### GS1 DataBar Limited

- **GS1 Limited Security Level** -
  - **GS1 Security Level 1** - This setting allows the scanner to operate in its most aggressive state, while providing sufficient security in decoding most “in-spec” barcodes.
  - **GS1 Security Level 2** - This setting eliminates most misdecodes (default).
  - **GS1 Security Level 3** - Select this option if Security level 2 fails to eliminate misdecodes.
  - **GS1 Security Level 4** - If Security Level 3 is selected and misdecodes still occur, select this security level. Be advised, selecting this option is an extreme measure against mis-decoding severely out of

spec barcodes. Selecting this level of security significantly impairs the decoding ability of the scanner. If this level of security is needed, try to improve the quality of the barcodes.

### HAN XIN

- **HAN XIN Inverse** (SE4750-SR, SE4850-ER, RS6000, and DS3678).
  - **Disable** - Disables decoding of HAN XIN inverse barcodes (default).
  - **Enable** - Enables decoding of HAN XIN inverse barcodes.
  - **Auto** - Decodes both HAN XIN regular and inverse barcodes.

### Interleaved 2 of 5

- **Check Digit**
  - **No Check Digit** - A check digit is not used. (default)
  - **USS Check Digit** - Select to check the integrity of all Interleaved 2 of 5 symbols to verify the data complies with either the Uniform Symbology Specification (USS) check digit algorithm.
  - **OPCC Check Digit** - Select to check the integrity of all Interleaved 2 of 5 symbols to verify the data complies with either the Optical Product Code Council (OPCC) check digit algorithm.
- **Length1** - Use to set decode lengths (default - 14). See [Decode Lengths on page 113](#) for more information.
- **Length2** - Use to set decode lengths (default - 10). See [Decode Lengths on page 113](#) for more information.
- **Redundancy** - Sets the reader to read the barcode twice before accepting data. A check in the checkbox indicates that redundancy is enabled (default - enabled).
- **Report Check Digit** - Transmit Interleaved 2 of 5 data with or without the check digit. A check in the checkbox indicates to send Interleaved 2 of 5 data with check digit (default - disabled).
- **I2of5 Security Level** - Options: **I2of5 Security level 0**, **I2of5 Security Level 1**, **I2of5 Security Level 2** and **I2of5 Security Level 3** (default - I2of5 Security level 1).
- **Convert ITF-14 To EAN13** - Convert 14-character Interleaved 2 of 5 barcodes to EAN-13, and transmit as EAN-13. The Interleaved 2 of 5 barcode must be enabled and must have a leading zero and a valid EAN-13 check digit. A check in the checkbox indicates that the option is enabled (default - disabled).
- **I2of5 Reduced Quiet Zone** - Enables decoding of margin-less I2of5 barcodes. (SE4750-SR and SE4850-ER)

### Matrix 2 of 5

- **Length1** - Use to set decode lengths (default - 10). See [Decode Lengths on page 113](#) for more information.
- **Length2** - Use to set decode lengths (default - 0). See [Decode Lengths on page 113](#) for more information.
- **Redundancy** - Sets the reader to read the barcode twice before accepting data. A check in the checkbox indicates that redundancy is enabled (default - disabled).
- **Report Check Digit** - Transmit Matrix 2 of 5 data with or without the check digit. A check in the checkbox indicates to send Matrix 2 of 5 data with check digit (default - enabled).
- **Verify Check Digit** - Enable this feature to check the integrity of all Matrix 2 of 5 symbols to verify that the data complies with a specified check digit algorithm (default - enabled).

## MSI

- **Check Digit** - With MSI symbols, one check digit is mandatory and always verified by the reader. The second check digit is optional.
  - **One Check Digit** - Verify one check digit (default).
  - **Two Check Digits** - Verify two check digits.
- **Check Digit Scheme** - Two algorithms are possible for the verification of the second MSI check digit. Select the algorithm used to encode the check digit.
  - **Mod-11-10** - First check digit is MOD 11 and second check digit is MOD 10 (default).
  - **Mod-10-10** - Both check digits are MOD 10.
- **Length 1** - Use to set decode lengths (default - 4). See [Decode Lengths on page 113](#) for more information.
- **Length 2** - Use to set decode lengths (default - 55). See [Decode Lengths on page 113](#) for more information.
- **Redundancy** - Sets the reader to read the barcode twice before accepting data. A check in the checkbox indicates that redundancy is enabled (default - enabled).
- **Report Check Digit** - Transmit MSI data with or without the check digit. A check in the checkbox indicates to send MSI data with check digit (default - disabled).

## Trioptic 39

- **Redundancy** - Sets the reader to read the bar code twice before accepting data. A check in the checkbox indicates that redundancy is enabled (default - disabled) (SE965, RS507/RS507X, RS6000, and DS3678).

## UK Postal

- **Report Check Digit** - Transmit UK Postal data with or without the check digit. A check in the checkbox indicates to send UK Postal data with check digit (default - disabled). (SE4750-SR, SE4850-ER, and RS507/RS507X).

## UPCA

- **Preamble** - Preamble characters are part of the UPC symbol consisting of Country Code and System Character. Select the appropriate option to match the host system.  
There are three options for transmitting a UPCA preamble:
  - **Preamble None** - Transmit no preamble.
  - **Preamble Sys Char** - Transmit System Character only (default).
  - **Preamble Country and Sys Char** - Transmit System Character and Country Code ("0" for USA). Select the appropriate option to match the host system.
- **Report Check Digit** - The check digit is the last character of the symbol used to verify the integrity of the data. Enables or disables this option. A check in the checkbox indicates that the option is enabled (default - enabled).

## UPCE0

- **Convert UPCE0 To UPCA** - Enable to convert UPCE0 (zero suppressed) decoded data to UPC-A format before transmission. After conversion, the data follows UPC-A format and is affected by UPC-A programming selections. Disable to transmit UPCE0 decoded data as UPCE0 data, without conversion (default - disabled).



- **Preamble** - Preamble characters are part of the UPC symbol consisting of Country Code and System Character. Select the appropriate option to match the host system.  
There are three options for transmitting a UPCE0 preamble:
  - **Preamble None** - Transmit no preamble (default).
  - **Preamble Sys Char** - Transmit System Character only.
  - **Preamble Country and Sys Char** - Transmit System Character and Country Code ("0" for USA).
- **Report Check Digit** - The check digit is the last character of the symbol used to verify the integrity of the data. Enables or disables this option. A check in the checkbox indicates that the option is enabled (default - disabled).

### UPCE1

- **Convert UPCE1 To UPCA** - Enable this to convert UPCE1 decoded data to UPC-A format before transmission. After conversion, the data follows UPC-A format and is affected by UPC-A programming selections. Disable this to transmit UPCE1 decoded data as UPCE1 data, without conversion (default - disabled).
- **Preamble** - Preamble characters are part of the UPC symbol consisting of Country Code and System Character. Select the appropriate option to match the host system.  
There are three options for transmitting a UPCE1 preamble:
  - **Preamble None** - Transmit no preamble (default).
  - **Preamble Sys Char** - Transmit System Character only.
  - **Preamble Country and Sys Char** - Transmit System Character and Country Code ("0" for USA).
- **Report Check Digit** - The check digit is the last character of the symbol used to verify the integrity of the data. Enables or disables this option. A check in the checkbox indicates that the option is enabled (default - disabled).

### US Planet

- **Report Check Digit** - The check digit is the last character of the symbol used to verify the integrity of the data. Enables or disables this option. A check in the checkbox indicates that the option is enabled (default - disabled). (SE4750-SR and SE4850-ER)

### Decode Lengths

The allowable decode lengths are specified by options **Length1** and **Length2** as follows:

- Variable length: Decode symbols containing any number of characters.
  - Set both **Length1** and **Length2** to 0.
- Range: Decode a symbol with a specific length range (from *a* to *b*, including *a* and *b*).
  - Set **Length1** to *a* and set **Length2** to *b*.
- Two Discrete Lengths: Decode only symbols containing either of two selected lengths.
  - Set both **Length1** or **Length2** to the specific lengths. **Length1** must be greater than **Length2**.
- One Discrete Length: Decode only symbols containing a specific length.
  - Set both **Length1** and **Length2** to the specific length.

### UPC EAN Params

Allows the configuration of the parameters that apply to more than one UPC or EAN decoder.

- **Convert DataBar To UPC EAN** - If this is set it converts DataBar barcodes to UPC/EAN format. For this setting to work UPC/EAN symbologies must be enabled. A check in the checkbox indicates that the option is enabled. (default - disabled).
- **UPC Reduced Quiet Zone** - Enables decoding of margin-less UPC barcodes. (default - disabled) (SE4750-SR, SE4850-ER, RS6000, and DS3678)
- **Bookland** - Enable Bookland decoding. A check in the checkbox indicates that the option is enabled. (default - disabled).
- **Bookland Format** - If Bookland EAN is enabled, select one of the following formats for Bookland data:
  - **Format ISBN-10** - The decoder reports Bookland data starting with 978 in traditional 10-digit format with the special Bookland check digit for backward-compatibility. Data starting with 979 is not considered Bookland in this mode. (default)
  - **Format ISBN-13** - The decoder reports Bookland data (starting with either 978 or 979) as EAN-13 in 13-digit format to meet the 2007 ISBN-13 protocol.
- **Coupon** - Enables Coupon code decoding. Note that in order to successfully decode Coupon codes, all of the correct decoders must be enabled. A check in the checkbox indicates that the option is enabled. (default - disabled).
- **Coupon Report Mode** - Traditional coupon symbols are composed of two barcode: UPC/EAN and Code 128. A new coupon symbol is composed of a single Data Expanded barcode. The new format offers more options for purchase values (up to \$999.999) and supports complex discount offers as a second purchase requirement. An interim coupon symbol also exists that contain both types of barcodes: UPC/EAN and Databar Expanded. This format accommodates both retailers that do not recognize or use the additional information included in the new coupon symbol, as well as those who can process new coupon symbols.
  - **Old Coupon Report Mode** - Scanning an old coupon symbol reports both UPC and Code 128, scanning an interim coupon symbol reports UPC, and scanning a new coupon symbol reports nothing (no decode).
  - **New Coupon Report Mode** - Scanning an old coupon symbol reports either UPC or Code 128, and scanning an interim coupon symbol or a new coupon symbol reports Databar Expanded.
  - **Both Coupon Report Modes** - Scanning an old coupon symbol reports both UPC and Code 128, and scanning an interim coupon symbol or a new coupon symbol reports Databar Expanded. (default)
- **Ean Zero Extend** – Enable this parameter to add five leading zeros to decoded EAN-8 symbols to make them compatible in format to EAN-13 symbols. Disable this to transmit EAN-8 symbols as is. Default – disabled.
- **Linear Decode** - This option applies to code types containing two adjacent blocks (e.g., UPC-A, EAN-8, EAN-13). Enable this parameter to transmit a bar code only when both the left and right blocks are successfully decoded within one laser scan. Enable this option when bar codes are in proximity to each other (default - enabled) (SE965, RS507/RS507X, RS6000, and DS3678).
- **Retry Count** - Retry count for auto-discriminating for supplementals. Possible values are 2 to 20 inclusive. Note that this flag is only considered if Supplemental Mode - UPC EAN is set to one of the following values: **Supplementals Auto**, **Supplementals Smart**, **Supplementals 378-379**, **Supplementals 978-979**, **Supplementals 977** or **Supplementals 414-419-434-439** (2 to 20, default 10).

- **Security Level** - The scanner offers four levels of decode security for UPC/EAN barcodes. Select higher security levels for lower quality barcodes. There is an inverse relationship between security and decode speed, so be sure to choose only that level of security necessary for the application.
  - **Level 0** - This default setting allows the scanner to operate fastest, while providing sufficient security in decoding “in-spec” UPC/EAN barcodes.
  - **Level 1** - As barcode quality levels diminish, certain characters become prone to misdecodes before others (i.e., 1, 2, 7, 8). If the scanner is misdecoding poorly printed barcodes, and the misdecodes are limited to these characters, select this security level. (default).
  - **Level 2** - If the scanner is misdecoding poorly printed barcodes, and the misdecodes are not limited to characters 1, 2, 7, and 8, select this security level.
  - **Level 3** - If the scanner is still misdecoding, select this security level. Be advised, selecting this option is an extreme measure against misdecoding severely out of spec barcodes. Selecting this level of security can significantly impair the decoding ability of the scanner. If this level of security is necessary, try to improve the quality of the barcodes.
- **Supplemental2** - Enables or disables this option. A check in the checkbox indicates that the option is enabled.
- **Supplemental5** - Enables or disables this option. A check in the checkbox indicates that the option is enabled.
- **Supplemental Mode**
  - **No Supplementals** - the scanner is presented with a UPC/EAN plus supplemental symbol, the scanner decodes UPC/EAN and ignores the supplemental characters (default).
  - **Supplemental Always** - the scanner only decodes UPC/EAN symbols with supplemental characters, and ignores symbols without supplementals.
  - **Supplementals Auto** - the scanner decodes UPC/EAN symbols with supplemental characters immediately. If the symbol does not have a supplemental, the scanner must decode the barcode the number of times set via UPC/EAN Supplemental Redundancy before transmitting its data to confirm that there is no supplemental.
  - **Supplemental Smart** - Enables smart supplementals. In this mode the decoder returns the decoded value of the main block right away if it does not belong to one of the following supplemental types: 378, 379, 977, 978, 979, 414, 419, 434 or 439. If the barcode starts with one of the prefixes it searches the image more aggressively for a supplemental. Tries to scan the supplemental if it is present. If the supplemental scanning failed, then the main barcode is returned.
  - **Supplemental 378-379** - Enables (auto-discriminate) supplemental for UPC/EAN codes starting with 378 or 379. Disables reading of supplementals for any other UPC/EAN barcode not starting with 378 or 379. Tries to scan the supplemental if it is present. If the supplemental scanning failed, then the main barcode is returned.
  - **Supplemental 978-979** - Enables (auto-discriminate) supplemental for UPC/EAN codes starting with 978 or 979. Disables reading of supplementals for another UPC/EAN barcode not starting with 978 or 979. Tries to scan the supplemental if it is present. If the supplemental scanning failed, then the main barcode is returned.
  - **Supplemental 414-419-434-439** - Enables (auto-discriminate) supplemental for UPC/EAN codes starting with 414, 419, 434 or 439. Disables reading of supplementals for another UPC/EAN barcode 4 - 16 not starting with 414, 419, 434 or 439. Tries to scan the supplemental if it is present. If the supplemental scanning failed, then the main barcode is returned.
  - **Supplemental 977** - Enables (auto-discriminate) supplemental for UPC/EAN codes starting with 977. Disables reading of supplementals for another UPC/EAN barcode not starting with 977. Tries to scan the supplemental if it is present. If the supplemental scanning failed, then the main barcode is returned.

## Reader Params

Allows the configuration of parameters specific to the selected barcode reader.

- **1D Quiet Zone Level** - Sets the level of aggressiveness in decoding barcodes with a reduced quiet zone (the area in front of and at the end of a barcode), and applies to symbologies enabled by a Reduced Quiet Zone parameter. Because higher levels increase the decoding time and risk of misdecodes, Zebra strongly recommends enabling only the symbologies which require higher quiet zone levels, and leaving Reduced Quiet Zone disabled for all other symbologies. (SE4750-SR and SE4850-ER).  
Options are:
  - **0** - The scanner performs normally in terms of quiet zone.
  - **1** - The scanner performs more aggressively in terms of quiet zone (default).
  - **2** - The scanner only requires one side EB (end of barcode) for decoding.
  - **3** - The scanner decodes anything in terms of quiet zone or end of barcode.
- **Aim mode** - Turns the scanner cross-hairs on or off. (SE4750-SR and SE4850-ER)
  - **On** - Cross-hair is on (default).
  - **Off** - Cross-hair is off.
- **Adaptive Scanning** - When adaptive scanning is enabled, the scan engine toggles between wide and narrow, allowing the scan engine to decode barcodes based on the distance. (SE965).
  - **Disable**
  - **Enable** (default).
- **Beam Width** - Beam Width is applicable only with linear scanners. (SE965)
  - **Narrow**
  - **Normal** (default)
  - **Wide**
- **Character Set Selection** - (SE965, SE4750-SR, and SE4850-ER).
  - **ISO-8859-1** - part of the ISO/IEC 8859 series of ASCII-based standard character encodings. It is generally intended for Western European languages.
  - **Shift\_JIS** - Shift Japanese Industrial Standards (JIS) is a character encoding for the Japanese language.
  - **UTF-8** - A character encoding capable of encoding all possible characters, or code points, defined by Unicode (default).
- **Time Delay to Low Power** - Sets the time the decoder remains active after decoding. After a scan session, the decoder waits this amount of time before entering Low Power Mode. Options: **1 Second** (default), **30 Seconds**, **1 Minute** or **5 Minutes** (SE965, RS507/RS507X, and RS6000).
- **Illumination Brightness** - Sets the brightness of the illumination by altering LED power. The default is 10, which is maximum LED brightness. For values from 1 to 10, LED brightness varies from lowest to highest level of brightness (RS507/RS507X and RS6000).
- **Illumination mode** - Turns imager illumination on and off. This option is only available when **Bluetooth Scanner** is selected in the **Barcode input, Scanner selection** option. (SE4750-SR, and SE4850-ER)
  - **Off** - Illumination is off.
  - **On** - Illumination is on (default).

- **Inverse 1D Mode** - This parameter allows the user to select decoding on inverse 1D barcodes (SE965, SE4750-SR, SE4850-ER, RS507/RS507X, and RS6000).
  - **Disable** - Disables decoding of inverse 1D barcodes (default).
  - **Enable** - Enables decoding of only inverse 1D barcodes.
  - **Auto** - Allows decoding of both twice positive and inverse 1D barcodes.
- **Keep Pairing Info After Reboot** - DS3678 only.
  - **Disable** - Disables the ability to keep pairing info after reboot.
  - **Enable** - Enables the ability to keep pairing info after reboot. (default).
- **LCD Mode** - Enables or disables LCD mode. LCD mode enhances the ability of the imager to read barcodes from LCD displays such as cellphones (SE4750-SR, SE4850-ER, and RS507/RS507X).
  - **Disable** - Disables the LCD mode (default).
  - **Enable** - Enables LCD mode.
- **Linear Security Level** - Sets the number of times a barcode is read to confirm an accurate decode: (SE4750-SR and SE4850-ER).
  - **Security Short or Codabar** - Two times read redundancy if short barcode or Codabar (default).
  - **Security All Twice** - Two times read redundancy for all barcodes.
  - **Security Long and Short** - Two times read redundancy for long barcodes, three times for short barcodes.
  - **Security All Thrice** - Three times read redundancy for all barcodes.
- **HW Engine Low Power Timeout** - Time (0 - 1,000 ms in increments of 50 ms) of inactivity before scanner enters low-power mode from (default - 250). (SE4750-SR and SE4850-ER).
- **Picklist** - Allows the imager to decode only the barcode that is directly under the cross-hair/reticle (+) part of the pattern. This feature is useful in applications where multiple barcodes may appear in the field of view during a decode session and only one of them is targeted for decode (SE4750-SR, SE4850-ER, and RS507/RS507X).
  - **Disabled** – Disables Picklist mode. Any barcode within the field of view can be decoded (default).
  - **Enabled** – Enables Picklist mode so that only the barcode under the projected reticle can be decoded.
- **Poor Quality Decode Effort** - Enable poor quality barcode decoding enhancement feature. (SE4750-SR and SE4850-ER).
- **Aim Timer** - Sets the maximum amount of time that aiming remains on (0 - 60,000 ms in increments of 100 ms). A value of 0 sets the aim to stay on indefinitely (default - 500).
- **Aim Type** - Set the aiming usage (RS507/RS507X only).
  - **Trigger** - A trigger event activates decode processing, which continues until the trigger event ends or a valid decode occurs (default).
  - **Timed Hold** - A trigger pull and hold activates the laser for aiming, which continues until the trigger is released, a valid decode, or the decode session time-out is expired.
  - **Timed Release** - A trigger pull activates the laser for aiming, which continues until a valid decode or the remaining decode session time has expired.
  - **Press and Release** - A trigger pull and release activates the laser for aiming, which continues until a trigger is pressed again, a valid decode, or the decode session time-out is expired.
  - **Continuous Read** - When the imager detects an object in its field of view, it triggers and attempt to decode.
- **Beam Timer** - Sets the maximum amount of time that the reader remains on (0 - 60,000 ms in increments of 100 ms). A value of 0 sets the reader to stay on indefinitely (default -5000).

- **Different Symbol Timeout** - Controls the time the scanner is inactive between decoding different symbols. Programmable in 500 msec increments from 0 to 5 seconds. The default is 500 msec.
- **Same Symbol Timeout** - Controls the time the scanner is inactive between decoding same symbols. Programmable in 500 msec increments from 0 to 5 seconds. The default is 500 msec.
- **Scanning Modes** - Scanning options available on the device. (SE4750-SR and SE4850-ER).
  - **Single** - Set to scan general barcodes (default).
  - **UDI** - Set to scan healthcare specific barcodes,

## Scan Params

Allows the configuration of Code ID and decode feedback options.

- **Code ID Type** - A Code ID character identifies the code type of a scanned barcode. This is useful when the reader is decoding more than one code type. Select a code ID character to insert between the prefix and the decoded symbol.
  - **Code ID Type None** - No prefix (default)
  - **Code ID Type AIM** - Insert AIM Character prefix.
  - **Code ID Type Symbol** - Insert Symbol character prefix.
- **Engine Decode LED** - Use to turn on scanner red LED when the scan beam is emitting either by scanner trigger or using soft scan button (RS507/RS507X).
- **BT Disconnect On Exit** - Bluetooth connection is disconnected when data capture application is closed (RS507/RS507X, RS6000 and DS3678).
- **Connection Idle Time** - Set connection idle time. The Bluetooth connection disconnects after being idle for set time (RS507/RS507X, RS6000 and DS3678).
- **Display BT Address Barcode** - Enable or disable displaying Bluetooth Address bar code if there is no Bluetooth scanner being paired when application tries to enable the Bluetooth scanner (RS507/RS507X and RS6000).
- **Establish Connection Time** - The timeout which the device will try to enable or reconnect to the Bluetooth scanner when the Bluetooth scanner is not in the vicinity or not paired (RS507/RS507X and RS6000).
- **Audio Feedback Mode** - Select good decode audio indication (RS507/RS507X, RS6000, and DS3678).
  - **Local Audio Feedback** - Good decode audio indication on MC33XX only.
  - **Remote Audio Feedback** - Good decode audio indication on RS507/RS507X, RS6000, and DS3678.
  - **Both** - Good decode audio indication on MC33XX and RS507/RS507X, RS6000, and DS3678 (default).
  - **Disable** - No good decode audio indication on either MC33XX or RS507/RS507X, RS6000, and DS3678).
- **LED Feedback Mode** - Select good decode LED indication (RS507/RS507X, RS6000, and DS3678).
  - **Local LED Feedback** - Good decode LED indication on MC33XX only.
  - **Remote LED Feedback** - Good decode LED indication on RS507/RS507X, RS6000, and DS3678.
  - **Both** - Good decode LED indication on MC33XX and RS507/RS507X, RS6000, and DS3678 (default).
  - **Disable** - No good decode LED indication on either MC33XX or RS507/RS507X, RS6000, and DS3678).
- **Decode Audio Feedback** - Select an audio tone to sound upon a good decode (default optimized-beep).
- **Decoding LED Notification** - Enable the device to light the red Data Capture LED when data capture is in progress. (default - disabled).

- **Decode Feedback LED Timer** - Set the amount of time (in milliseconds) that the green Data Capture LED stays lit after a good decode. (default - 75 msec.)
- **Beep Volume Control** - Set the good decode beep to a system or other sound. This allows for independent control of the good beep volume.



**NOTE:** Not all ringtones are fully supported as decode tones and those of longer length may be truncated when used as a decode tone. The recommendation is to test the selected tone for operation before deployment to a customer site.

- **Ringer** - Set the good decode beep to the ringer sound.
- **Music and Media** - Set the good decode beep to the media sound.
- **Alarms** - Set the good decode beep to the alarm sound.
- **Notifications** - Set the good decode beep to the notification sound (default).

### UDI Params

Allows the configuration of parameters specific to healthcare barcodes (SE4750-SR and SE4850-ER).

- **Enable UDI-GSI** - Enable UDI using GS1 standards (default - enabled).
- **Enable UDI-HIBCC** - Enable UDI using HIBCC standards (default - enabled).
- **Enable UDI-ICCBBA** - Enable UDI using ICCBBA standards (default - enabled).

### Keep enabled on suspend

Keep Bluetooth scanner enabled after suspend (default-disabled).

### Simulscan Input

Use the **SimulScan Input** to configure the SimulScan Input Plug-in.



**NOTE:** Simulscan supports devices with an SE4750 imager.

- **Enabled** - Enables or disables this plug-in. A check in the checkbox indicates that the plug-in is enabled.
- **Device Selection** - Configures which scanning device to use for data capture when the profile is active.
  - **Camera** - Scanning is performed with the rear-facing camera.
  - **Imager** - Scanning is performed using the integrated 2D Imager.
  - **Default** - Scanning is performed with the default selected scanning device (default).

- **Template Selection** - Select template to use.
  - **Default - BankCheck.xml** – Use this template to read the MICR E-13B font (length between 19 and 40 characters) on bank checks.
  - **Default - Barcode 1.xml** – Use this template to read a single supported bar code.
  - **Default - Barcode 10.xml** – Use this template to read up to 10 supported bar codes.
  - **Default - Barcode 2.xml** – Use this template to read two supported bar codes.
  - **Default - Barcode 4.xml** – Use this template to read up to supported four bar codes.
  - **Default - Barcode 5.xml** – Use this template to read up to supported five bar codes.
  - **Default - BookNumber.xml** – Use this template to read the OCR-B ISBN 10 or 13 digit book numbers.
  - **Default - DocCap + Optional Barcode.xml** – Use this template to capture a full page image and decode any supported bar codes that are in the form. The captured area is the largest rectangular region in the field of view defined by the solid border or contrast of background. Any OCR or OMR content will not be decoded in this mode. The captured area is further processed to correct, de-skew and sharpen and returned as a picture(default).
  - **Default - DocCap + Required Barcode.xml** – Use this template to capture a full page image and decode of any supported bar codes that are present in the form. The captured area is the largest rectangular region in the field of view defined by the solid border or contrast of background. Any OCR or OMR content will not be decoded in this mode. The captured area is further processed to correct, de-skew and sharpen and returned as a picture.
  - **Default - TravelDoc.xml** – Use this template to read passport and Visa travel documents with OCR-B types A and B fonts.
  - **Default - Unstructured Multi-Line.xml** – Use this template to read up to seven lines of text.
  - **Default - Unstructured Single Line.xml** – Use this template to read a single line of text.
- **Region separator** - Use to configure a separator character for SimulScan region data. When there are multiple text regions the region separator will be inserted between two data strings. By default no separator will be set. Possible values for region separator are **None**, **Tab**, **Line feed** and **Carriage return**. Region separator can be used with the Keystrokes plug-in Action key character setting to dispatch SimulScan region data to separate text fields.
- **Log directory** - Select a folder for storing log files to help debug a template. The folders are named based on the timestamp of the session and the debug data saved includes logs, templates, frame data, etc.
- **Timestamp** - Enable to capture the time when the data was captured and processed in case of a successful SimulScan session.

## Keystroke Output

Use to configure the Keystroke Output Plug-in for the profile.

- **Enabled** — Enables or disables this plug-in. A check in the checkbox indicates that the plug-in is enabled (default - enabled).



- **Action key character** - Enables decoding of a special character embedded within a barcode data for use in native Android applications. This feature is helpful when populating or executing a form.
  - **None** - Action key character feature is disabled (default).
  - **Tab** - Tab character code in a barcode is processed. When DataWedge detects this character code in a barcode, move the focus to the next field.
  - **Line feed** - Line feed character code in a barcode is processed. When DataWedge detects this character code in a barcode, move the focus to the next field.
  - **Carriage return** - Carriage return character code in a barcode is processed. When DataWedge detects this character code in a barcode, move the focus to the next field.
- **Multi byte character display** - Set the amount of time (in milliseconds) of the inter character delay for multi byte characters. (default - 0.)
- **Key event delay** - Set the amount of time (in milliseconds) of the wait time for control characters. (default - 0.)
- **Token selection** - Allows the output order of acquired UDI data to be adjusted and the optional insertion of a tab, line feed or carriage return character between tokens.
  - **Send tokens** - Set to select the output format for UDI data. (default - disabled)
  - **Token separator** - Set to select a separator character. If no separator character is selected when Send tokens is set to Barcodes and tokens, two instances of the same data are sent. (default - none)
  - **Token order** - Set to include or exclude Tokens from the output and adjust their output order.
- **Advanced data formatting** - is a way to customizing data before transmission. Use advanced data formatting (ADF) to edit scan data to suit requirements.
  - **Enable** - Enables or disables ADF. A check in the checkbox indicates that ADF is enabled (default - disabled).
  - **Rules** - ADF uses rules to customize data. These rules perform detailed actions when the data meets certain criteria. One rule may consist of single or multiple criteria applied to single or multiple actions. See [Generating Advanced Data Formatting Rules on page 127](#) for more information.
- **Basic data formatting** - Allows the configuration of any data formatting for the related Output Plug-in. When the plug-in is disabled, any data is passed on without modification.
  - **Enabled** - Enables or disables Basic Data Formatting. A check in the checkbox indicates that it is enabled (default - enabled).
  - **Prefix to data** - Add characters to the beginning of the data when sent.
  - **Suffix to data** - Add characters to the end of the data when sent.
  - **Send data** - Set to transfer the captured data to the foreground application. Disabling this option prevents the actual data from being transmitted. However, the prefix and suffix strings, if present, are still transmitted even when this option is disabled (default - enabled).
  - **Send as hex** - Set to send the data in hexadecimal format. A check in the checkbox indicates that the plug-in is enabled (default - disabled).
  - **Send TAB key** - Set to append a tab character to the end of the processed data. A check in the checkbox indicates that the plug-in is enabled (default - disabled).
  - **Send ENTER key** - Set to append an Enter character to the end of the processed data. A check in the checkbox indicates that the plug-in is enabled (default - disabled).

## Intent Output

Allows configuration of the Intent Output Plug-in for the profile. The Intent Output Plug-in allows the captured data to be sent to an application in the form of an implicit Intent. Refer to the Android Developer web site for more information, <http://developer.android.com>.

- **Enabled** - Enables or disables this plug-in. A check in the checkbox indicates that the plug-in is enabled (default - disabled).
- **Intent action** - Enter the Intent Action name (required).
- **Intent category** - Enter the Intent Category name (required).
- **Intent delivery** - Select the method by which the intent is delivered:
  - Send via StartActivity
  - Send via startService (default)
  - Broadcast intent
- **Receiver foreground flag** - Set Broadcast intent flag in Intent delivery. (DS3678).
- **Advanced data formatting** - is a way to customizing data before transmission. Use advanced data formatting (ADF) to edit scan data to suit requirements.
  - **Enable** - Enables or disables ADF. A check in the checkbox indicates that ADF is enabled (default - disabled).
  - **Rules** - ADF uses rules to customize data. These rules perform detailed actions when the data meets certain criteria. One rule may consist of single or multiple criteria applied to single or multiple actions. See [Generating Advanced Data Formatting Rules on page 127](#) for more information.
- **Basic data formatting** - Allows configuration of any data formatting for the related Output Plug-in. When the plug-in is disabled any data is passed on without modification.
  - **Enabled** - Enables or disables Basic Data Formatting. A check in the checkbox indicates that it is enabled (default - enabled).
  - **Prefix to data** - Add characters to the beginning of the data when sent.
  - **Suffix to data** - Add characters to the end of the data when sent.
  - **Send data** - Set to transfer the captured data to the foreground application. Disabling this option prevents the actual data from being transmitted. However, the prefix and suffix strings, if present, are still transmitted even when this option is disabled (default - enabled).
  - **Send as hex** - Set to send the data in hexadecimal format. A check in the checkbox indicates that the plug-in is enabled (default - disabled).
  - **Send TAB key** - Set to append a tab character to the end of the processed data. A check in the checkbox indicates that the plug-in is enabled (default - disabled).
  - **Send ENTER key** - Set to append an Enter character to the end of the processed data. A check in the checkbox indicates that the plug-in is enabled (default - disabled).

## Intent Overview

The core components of an Android application (its activities, services, and broadcast receivers) are activated by intents. An intent is a bundle of information (an Intent object) describing a desired action - including the data to be acted upon, the category of component that should perform the action, and other pertinent instructions. Android locates an appropriate component to respond to the intent, launches a new instance of the component if one is needed, and passes it the Intent object.

Components advertise their capabilities, the kinds of intents they can respond to, through intent filters. Since the system must learn which intents a component can handle before it launches the component, intent filters are

specified in the manifest as `<intent-filter>` elements. A component may have any number of filters, each one describing a different capability. For example, if the manifest contains the following:

```
<intent-filter . . . >
<action android:name="android.intent.action.DEFAULT" />
<category android:name="android.intent.category.MAIN" />
</intent-filter>
```

In the Intent output plug-in configuration, the **Intent action** would be:

```
android.intent.category.DEFAULT
```

and the Intent category would be:

```
android.intent.category.MAIN.
```

The **Intent delivery** option allows the method by which the intent is delivered to be specified. The delivery mechanisms are **Send via startActivity**, **Send via startService** or **Broadcast intent**.

The decode related data added to the Intent's bundle can be retrieved using the `Intent.getStringExtra()` and `Intent.getSerializableExtra()` calls, using the following String tags:

- String LABEL\_TYPE\_TAG = "com.symbol.emdk.datawedge.label\_type";
  - String contains the label type of the barcode.
- String DATA\_STRING\_TAG = "com.symbol.emdk.datawedge.data\_string";
  - String contains the output data as a String. In the case of concatenated barcodes, the decode data is concatenated and sent out as a single string.
- String DECODE\_DATA\_TAG = "com.symbol.emdk.datawedge.decode\_data";
  - Decode data is returned as a list of byte arrays. In most cases there will be one byte array per decode. For barcode symbologies that support concatenation e.g. Codabar, Code128, MicroPDF, etc., the decoded data is stored in multiple byte arrays (one byte array per barcode). Clients can get data in each byte array by passing an index.

Most scanning applications might want the user to be able to decode data and for that decode data to be sent to the **\*current\*** activity but not necessarily displayed. If this is the case, then the activity needs to be marked as 'singleTop' in its AndroidManifest.xml file. If your activity is not defined as singleTop, then on every decode, the system will create another copy of your Activity and send the decode data to this second copy.

Finally there will be a configuration option for each process plug-in so that the process plug-in can be configured specifically for the intent output, which in this case is the basic data formatting process plug-in.

## IP Output



**NOTE:** IPWedge application is required on a host computer. Download the IPWedge application from the Support Central web site: <http://www.zebra.com/support>.

IP Output allows DataWedge to send captured data to a host computer via a network connection. Captured data can be sent over an IP network to a specified IP address and port using either TCP or UDP transport protocols.

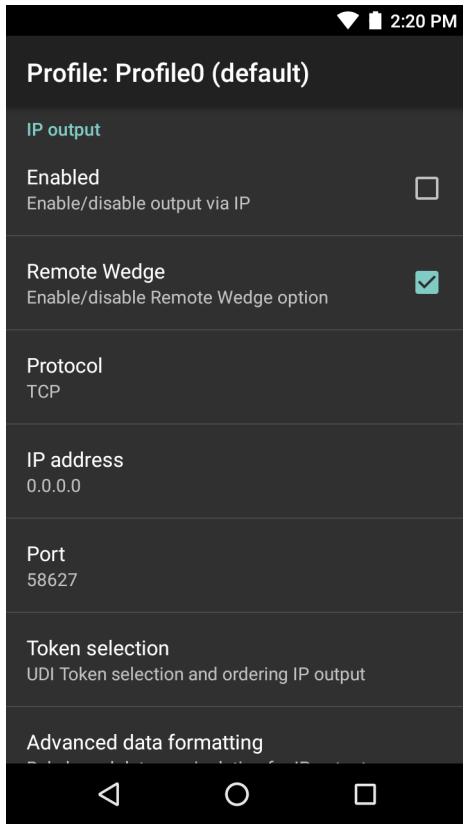
- **Enabled** - Enables or disables this plug-in. A check in the checkbox indicates that the plug-in is enabled (default - disabled).

- **Remote Wedge** - Enable or disable the Remote Wedge option (default - enabled). Remote Wedge is used with the IPWedge application.
- **Protocol** - Select the protocol used by the remote application. Options: **TCP** (default) or **UDP**.
- **IP address** - Enter the IP address used by the remote application (default - 0.0.0.0).
- **Port** - Enter the port number used by the remote application (default - 58627).
- **Token selection** - Allows the output order of acquired UDI data to be adjusted and the optional insertion of a tab, line feed or carriage return character between tokens.
  - **Send tokens** - Set to select the output format for UDI data. (default - disabled)
  - **Token separator** - Set to select a separator character. If no separator character is selected when Send tokens is set to Barcodes and tokens, two instances of the same data are sent. (default - none)
  - **Token order** - Set to include or exclude Tokens from the output and adjust their output order.
- **Advanced data formatting** - is a way of customizing data before transmission. Use advanced data formatting (ADF) to edit scan data to suit requirements.
  - **Enable** - Enables or disables ADF. A check in the checkbox indicates that ADF is enabled (default - disabled).
  - **Rules** - ADF uses rules to customize data. These rules perform detailed actions when the data meets certain criteria. One rule may consist of single or multiple criteria applied to single or multiple actions. See [Generating Advanced Data Formatting Rules on page 127](#) for more information.
- **Basic data formatting** - Allows configuration of any data formatting for the related Output Plug-in. When the plug-in is disabled any data is passed on without modification.
  - **Enabled** - Enables or disables Basic Data Formatting. A check in the checkbox indicates that it is enabled (default - enabled).
  - **Prefix to data** - Add characters to the beginning of the data when sent.
  - **Suffix to data** - Add characters to the end of the data when sent.
  - **Send data** - Set to transfer the captured data to the foreground application. Disabling this option prevents the actual data from being transmitted. However, the prefix and suffix strings, if present, are still transmitted even when this option is disabled (default - enabled).
  - **Send as hex** - Set to send the data in hexadecimal format. A check in the checkbox indicates that the plug-in is enabled (default - disabled).
  - **Send TAB key** - Set to append a tab character to the end of the processed data. A check in the checkbox indicates that the plug-in is enabled (default - disabled).
  - **Send ENTER key** - Set to append an Enter character to the end of the processed data. A check in the checkbox indicates that the plug-in is enabled (default - disabled).

### Usage

This section provides information on how to configure IP Output using the DataWedge configuration user interface. To use IP Output in a particular DataWedge profile (for example: **Profile0**), scroll downward on **IP Output**.

**Figure 89** IP Output Screen

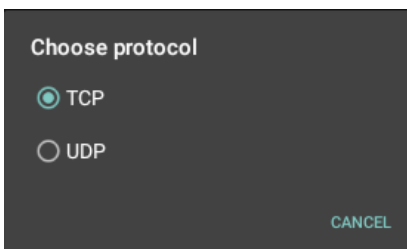


## Using IP Output with IPWedge

IPWedge is a computer application that can be easily configured to retrieve data sent over network by DataWedge IP Output. Refer to the IPWedge User Manual on how to install and configure in a host computer. To enable IP Output to send captured data to a remote computer that is installed with IPWedge:

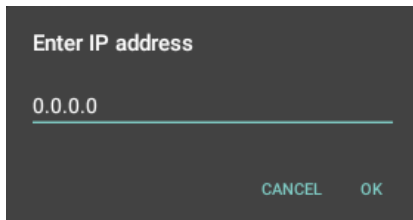
1. In **IP Output**, touch **Enabled**.  
A check appears in the checkbox.
2. Ensure **Remote Wedge** option is enabled.
3. Touch **Protocol**.
4. In the **Choose protocol** dialog box, touch the same protocol selected for the IPWedge computer application. (TCP is the default).

**Figure 90** Protocol Selection



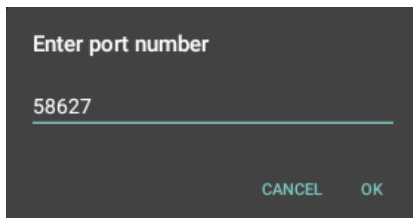
5. Touch **IP Address**.
6. In the **Enter IP Address** dialog box, enter the IP address of host computer to send data to.

**Figure 91** IP Address Entry



7. Touch **Port**.
8. In the **Enter port number** dialog box, enter same port number selected for IPWedge computer application.

**Figure 92** Port Number Entry



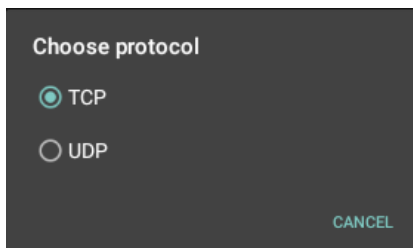
9. Configure **Advanced data formatting** and **Basic data formatting** Plug-in if any required modification to be done to captured data before sending to remote computer.

## Using IP Output without IPWedge

IP Output Plug-in can be used to send captured data from DataWedge to a remote device or host computer without using IPWedge. At the data receiving end, the host computer or mobile device should have an application, that listens to TCP or UDP data coming from a configured port and IP address in the IP Output plug-in. To enable IP Output to send captured data to a remote computer:

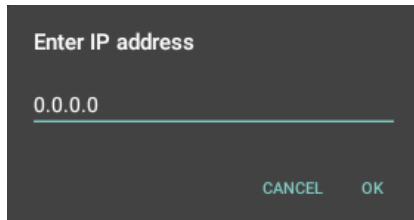
1. In **IP Output**, touch **Enabled**.  
A check appears in the checkbox.
2. Ensure **Remote Wedge** option is disabled.
3. Touch **Protocol**.
4. In the **Choose protocol** dialog box, touch the same protocol selected in the client application. (TCP is the default).

**Figure 93** Protocol Selection



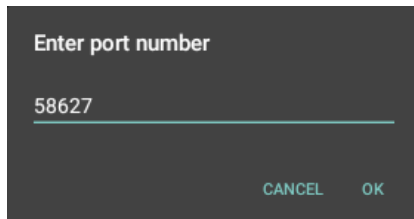
5. Touch **IP Address**.
6. In the **Enter IP address** dialog box, enter the IP address of host computer to send data to.

**Figure 94** IP Address Entry



7. Touch **Port**.
8. In the **Enter port number** dialog box, enter the port number that the host computer application is listening on.

**Figure 95** Port Number Entry



9. Configure **Advanced Data Formatting** and **Basic Data Formatting** Plug-in if any required modification to be done to captured data before sending to remote computer.

---


## Generating Advanced Data Formatting Rules

The ADF plug-in applies rules (actions to be performed based on defined criteria) to the data received via an input plug-in before sending it to the output plug-in.

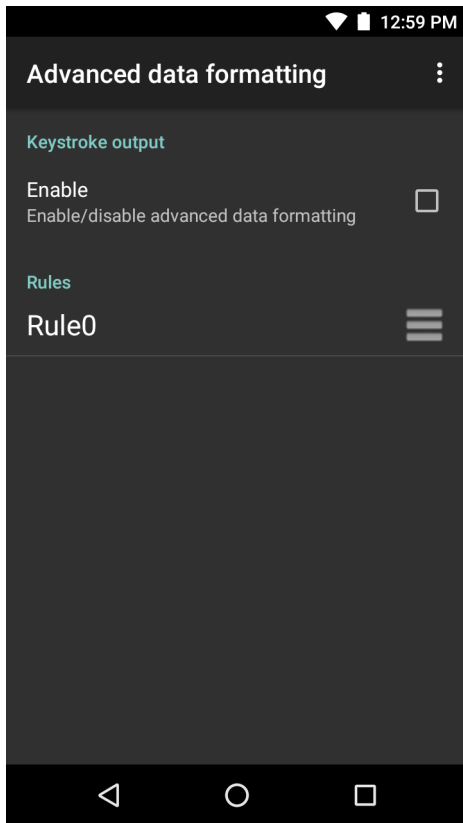
- **Rules** - The ADF process plug-in consists of one or more rules. DataWedge formats the output data according to the first matching rule. A rule is a combination of criteria and a set of actions to be performed, upon fulfillment of the criteria set in the rule.
- **Criteria** - Criteria can be set according to Input plug-in, symbology, matching string within the data (at the specified position) and/or data length. Received data must match the defined criteria in order for the data to be processed.
- **Actions** - A set of procedures defined to format data. There are four types of actions which are for formatting cursor movement, data modification, data sending and delay specifications. An action can be defined to send the first number of characters to the Output plug-in, pad the output data with spaces or zeros, remove spaces in data, etc.

## Configuring ADF Plug-in

Configuring the ADF plug-in consists of creating a rule, defining the criteria and defining the actions.

1. Swipe up from the bottom of the screen and touch .
2. Touch a DataWedge profile.
3. In **Keystroke Output**, touch **Advanced data formatting**.

**Figure 96** Advanced Data Formatting Screen



4. Touch the **Enable** checkbox to enable ADF.

## Creating a Rule



**NOTE:** By default, **Rule0**, is the only rule in the Rules list.

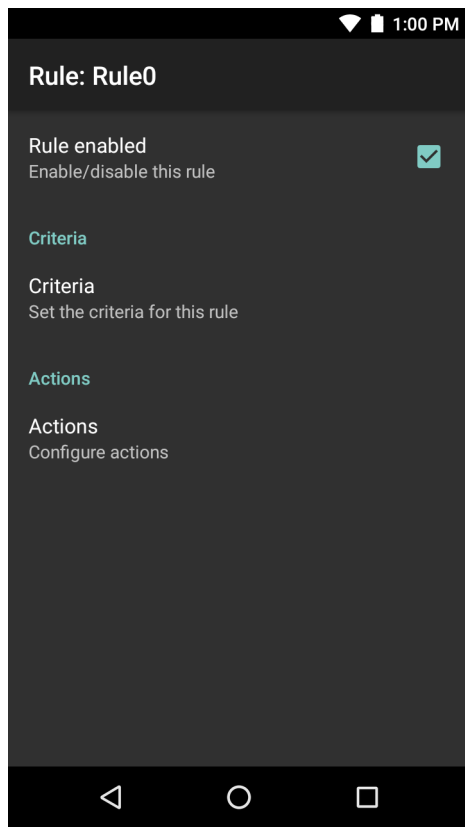
1. Touch **⋮**.
2. Touch **New rule**.
3. Touch the **Enter rule name** text box.
4. In the text box, enter a name for the new rule.
5. Touch **OK**.

## Defining a Rule

1. Touch the newly created rule in the **Rules** list.



**Figure 97** Rule List Screen

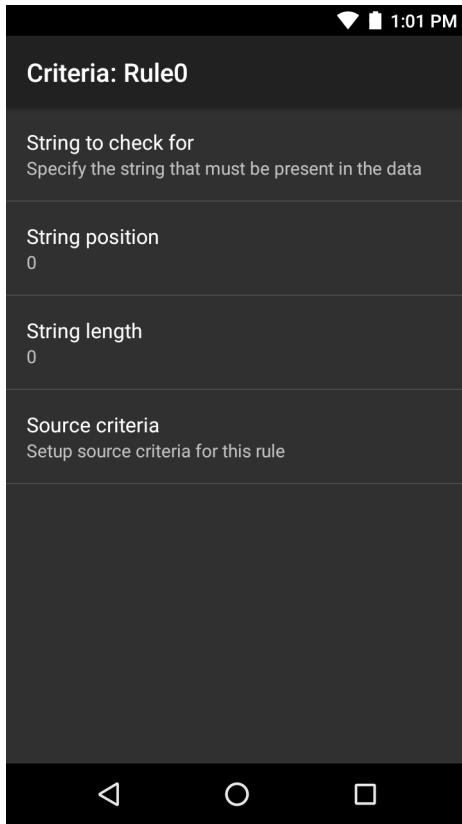


2. Touch the **Rule enabled** checkbox to enable the current rule.

## Defining Criteria

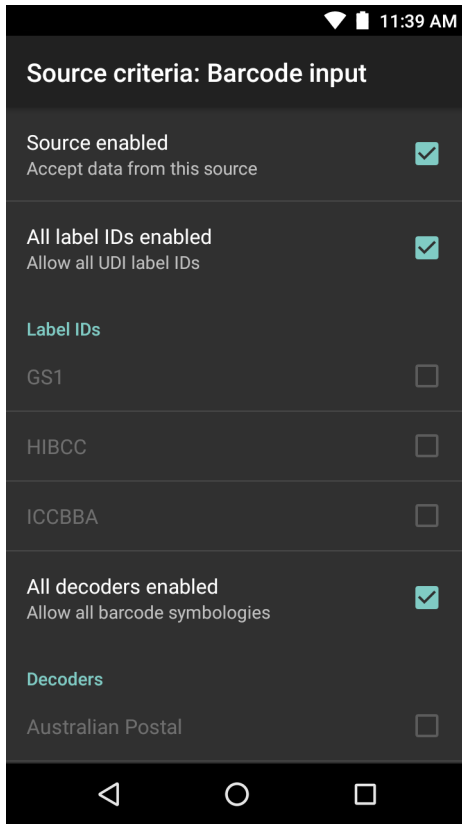
1. Touch **Criteria**.

**Figure 98** Criteria Screen



2. Touch **String to check for** option to specify the string that must be present in the data.
3. In the **Enter the string to check for** dialog box, enter the string
4. Touch **OK**.
5. Touch **String position** option to specify the position of the string specified in the **String to check for** option. The ADF rule is only applied if the specific string in **String to check for** is found at the specified **String position** location (zero for the start of the string).
6. Touch the **+** or **-** to change the value.
7. Touch **OK**.
8. Touch **String length option** to specify a length for the received data. The ADF rule only applies to the barcode data with that specified length.
9. Touch the **+** or **-** to change the value.
10. Touch **OK**.
11. Touch **Source criteria** option to associate an input device to an ADF rule. The ADF rule only applies to data received from associated input devices.
12. Touch **Barcode input**. Options vary depending upon the device configuration.
13. Touch the **Source enabled** checkbox to accept data from this source.

**Figure 99** Barcode Input Screen



14. For general barcode inputs, touch the **All decoders enabled** checkbox to select all bar code symbologies. Deselect the **All decoders enabled** checkbox to individually select the symbologies.
15. Touch until the **Rule** screen appears.
16. If required, repeat steps to create another rule.
17. Touch until the Rule screen appears.

## Defining an Action



**NOTE:** By default the **Send remaining** action is in the **Actions** list.

1. Touch .
2. Touch **New action**.
3. In the **New action** menu, select an action to add to the **Actions** list. See [Table 11 on page 132](#) for a list of supported ADF actions.
4. Some Actions require additional information. Touch the Action to display additional information fields.
5. Repeat steps to create more actions.
6. Touch .
7. Touch .

## Deleting a Rule

1. Touch and hold on a rule until the context menu appears.

2. Touch **Delete rule** to delete the rule from the **Rules** list.



**NOTE:** When there is no rule available for ADF plug-in or all rules are disabled, DataWedge passes decoded data to the output plug-in without processing the data.

## Order Rules List



**NOTE:** When there are no rules defined, ADF passes the captured data through as is. In contrast, when rules are defined but all are disabled, ADF does not pass any captured data through.

Rules are processed in top-down order. The rules that are on top of the list are processed first. Use the icon next to the rule to move it to another position in the list.

**Table 11** ADF Supported Actions

Type	Actions	Description
Cursor Movement	Skip ahead	Moves the cursor forward by a specified number of characters. Enter the number of characters to move the cursor ahead.
	Skip back	Moves the cursor back by a specified number of characters. Enter the number of characters to move the cursor back.
	Skip to start	Moves the cursor to the beginning of the data.
	Move to	Moves the cursor forward until the specified string is found. Enter the string in the data field.
	Move past a	Moves the cursor forward past the specified string. Enter the string in the data field.

**Table 11** ADF Supported Actions (Continued)

Type	Actions	Description
Data Modification	Crunch spaces	Remove spaces between words to one and remove all spaces at the beginning and end of the data.
	Stop space crunch	Stops space crunching. This disables the last <b>Crunch spaces</b> action.
	Remove all spaces	Remove all spaces in the data.
	Stop space removal	Stop removing spaces. This disables the last <b>Remove all spaces</b> action.
	Remove leading zeros	Remove all zeros at the beginning of data.
	Stop zero removal	Stop removing zeros at the beginning of data. This disables the previous <b>Remove leading zeros</b> action.
	Pad with zeros	Left pad data with zeros to meet the specified length. Enter the number zeros to pad.
	Stop pad zeros	Stop padding with zeros. This disables the previous <b>Pad with zeros</b> action.
	Pad with spaces	Left pad data with spaces to meet the specified length. Enter the number spaces to pad.
	Stop pad spaces	Stop padding with spaces. This disables the previous <b>Pad with spaces</b> action.
	Replace string	Replaces a specified string with a new string. Enter the string to replace and the string to replace it with.
	Stop all replace string	Stop all <b>Replace string</b> actions.
Data Sending	Send next	Sends the specified number of characters from the current cursor position. Enter the number of characters to send.
	Send remaining	Sends all data that remains from the current cursor position.
	Send up to	Sends all data up to a specified string. Enter the string.
	Send pause	Pauses the specified number of milliseconds before continuing the next action. Enter the amount of time in milliseconds.
	Send string	Sends a specified string. Enter the string to send.
	Send char	Sends a specified ASCII/ Unicode character. Enter a character value. The maximum Unicode character value can be entered is U-10FFFF (= 1114111 in decimal).

### Deleting an Action

1. Touch and hold the action name.
2. Select **Delete action** from the context menu.

### ADF Example

The following illustrates an example of creating Advanced Data Formatting:






When a user scans a barcode with the following criteria:




- Code 39 barcode.
- length of 12 characters.
- contains 129 at the start position.

Modify the data as follows:

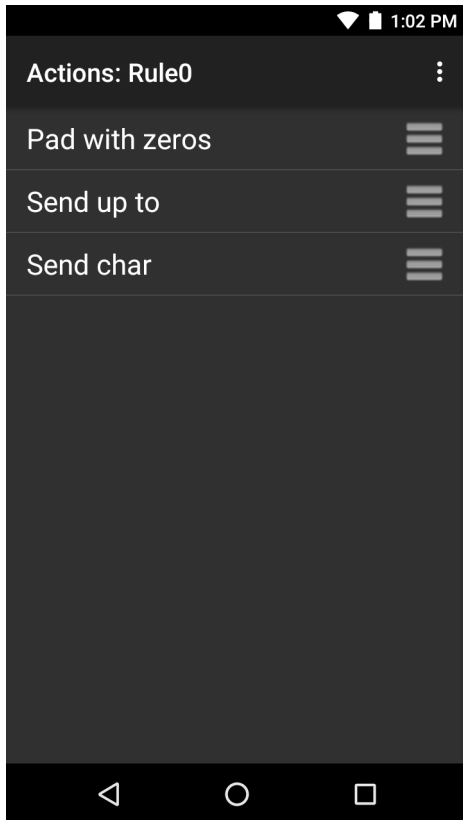
- Pad all sends with zeros to length 8.
- send all data up to character X.
- send a space character.

To create an ADF rule for the above example:

1. Swipe up from the bottom of the screen and touch .
2. Touch **Profile0**.
3. Under **Keystroke Output**, touch **Advanced data formatting**.
4. Touch **Enable**.
5. Touch **Rule0**.
6. Touch **Criteria**.
7. Touch **String to check for**.
8. In the **Enter the string to check for** text box, enter 129 and then touch **OK**.
9. Touch **String position**.
10. Change the value to 0.
11. Touch **OK**.
12. Touch **String length**.
13. Change value to 12.
14. Touch **OK**.
15. Touch **Source criteria**.
16. Touch **Barcode input**.
17. Touch **All decoders enabled** to disable all decoders.
18. Touch **Code 39**.
19. Press  three times.
20. Touch **Actions**.
21. Touch and hold on the **Send remaining rule** until a menu appears.
22. Touch **Delete action**.
23. Touch .
24. Touch **New action**.
25. Select **Pad with zeros**.
26. Touch the **Pad with zeros** rule.
27. Touch **How many**.
28. Change value to 8 and then touch **OK**.
29. Press .
30. Touch .
31. Touch **New action**.

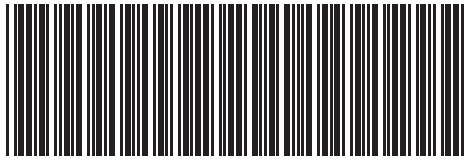
32. Select **Send up to**.
33. Touch **Send up to** rule.
34. Touch **String**.
35. In the **Enter a string** text box, enter x.
36. Touch **OK**.
37. Touch .
38. Touch .
39. Touch **New action**.
40. Select **Send char**.
41. Touch **Send char** rule.
42. Touch **Character code**.
43. In the **Enter character code** text box, enter 32.
44. Touch **OK**.
45. Touch .

**Figure 100** ADF Sample Screen



46. Ensure that an application is open on the device and a text field is in focus (text cursor in text field).
47. Aim the exit window at the barcode.

**Figure 101** Sample Barcode



1299X1559828

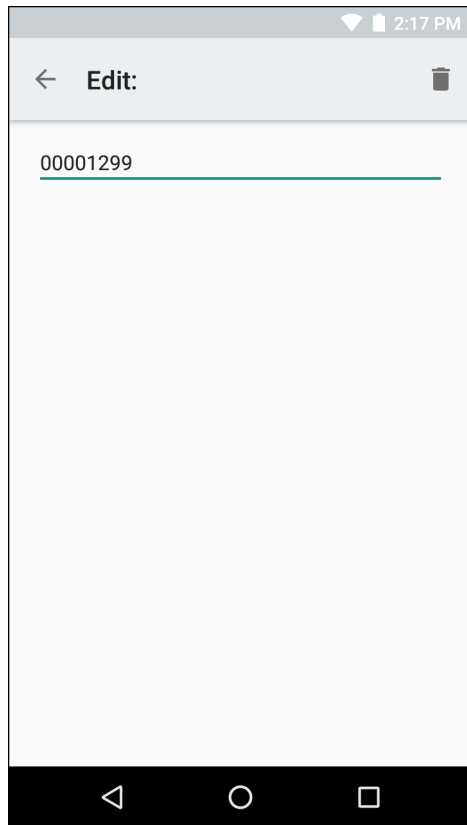
48. Press and hold the scan button.

The red laser aiming pattern turns on to assist in aiming. Ensure that the barcode is within the area formed by the aiming pattern. The LED light red to indicate that data capture is in process.

49. The LED lights green, a beep sounds and the device vibrates, by default, to indicate the barcode was decoded successfully. The LED lights green and a beep sounds, by default, to indicate the barcode was decoded successfully. The formatted data 000129X<space>appears in the text field.

Scanning a Code 39 barcode of 1299X15598 does not transmit data (rule is ignored) because the barcode data did not meet the length criteria.

**Figure 102** Formatted Data

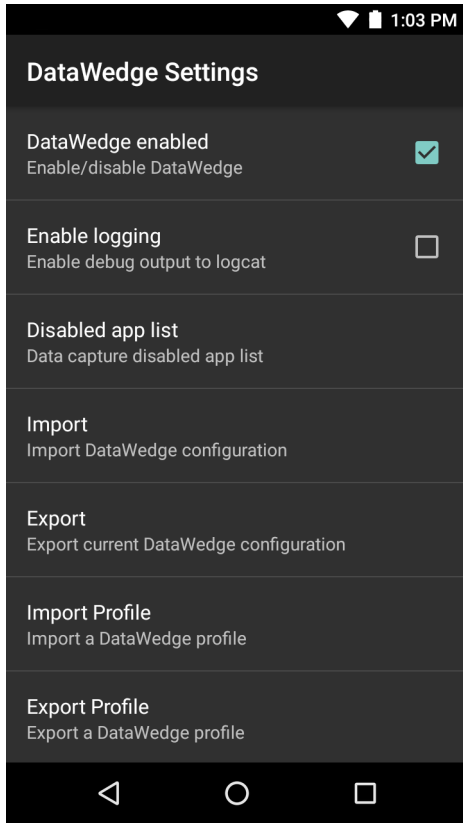


## DataWedge Settings

The DataWedge Settings screen provides access to general, non-profile related options. Touch **⋮** > **Settings**.





**Figure 103** DataWedge Settings Window





- **DataWedge enabled** - Enables or disables DataWedge. To disable DataWedge uncheck this option.
- **Enable logging** - Enables or disables debug output file to logcat. To enable logging check this option.
- **Disable app list** - Disables scanning functions for selected applications or activities.
- **Import** - allows import of a DataWedge configuration file. The imported configuration replaces the current configuration.
- **Export** - allows export of the current DataWedge configuration.
- **Import Profile** - allows import of a DataWedge profile file.
- **Export Profile** - allows export of a DataWedge profile.
- **Restore** - return the current configuration back to factory defaults.

## Importing a Configuration File

1. Copy the configuration file to the microSD card `/Android/data/com.symbol.datawedge/files` folder.
2. Swipe up from the bottom of the screen and touch .
3. Touch .
4. Touch **Settings**.
5. Touch **Import**.
6. Touch **filename to import**.

The configuration file (datawedge.db) is imported and replaces the current configuration.



## Exporting a Configuration File

1. Swipe up from the bottom of the screen and touch .
2. Touch .
3. Touch **Settings**.
4. Touch **Export**.
5. In the **Export to** dialog box, select the location to save the file.
6. Touch **Export**. The configuration file (datawedge.db) is saved to the selected location.



## Importing a Profile File



**NOTE:** Do not change the filename of the of the profile file. If the filename is changed, the file will not be imported.

1. Copy the profile file to the On Device Storage `/Android/data/com.symbol.datawedge` folder.
2. Swipe up from the bottom of the screen and touch .
3. Touch .
4. Touch **Settings**.
5. Touch **Import Profile**.
6. Touch the profile file to import.
7. Touch **Import**. The profile file (**dwprofile\_x.db**, where x = the name of the profile) is imported and appears in the profile list.



## Exporting a Profile

1. Swipe up from the bottom of the screen and touch .
2. Touch .
3. Touch **Settings**.
4. Touch **Export Profile**.
5. Touch the profile to export.
6. Touch **Export**.

The profile file (dwprofile\_x.db, where x = name of the profile) is saved to the root of the On-device Storage.

## Restoring DataWedge

To restore DataWedge to the factory default configuration:

1. Swipe up from the bottom of the screen and touch .
2. Touch .
3. Touch **Settings**.
4. Touch **Restore**.
5. Touch **Yes**.

---

## Configuration and Profile File Management

The configuration or profile settings for DataWedge can be saved to a file for distribution to other devices.

After making configuration or profile changes, export the new configuration or profile to the root of the On-device Storage. The configuration file created is automatically named `datawedge.db`. The profile file created is automatically named `dwprofile_x.db`, where `x` is the profile name. The files can then be copied to the On-device Storage of other devices and imported into DataWedge on those devices. Importing a configuration or profile replaces the existing settings.

### Enterprise Folder

Internal storage contains the Enterprise folder (`/enterprise`). The Enterprise folder is persistent and maintains data after an Enterprise reset. After an Enterprise Reset, DataWedge checks folder `/enterprise/device/settings/datawedge/enterprisereset/` for a configuration file, `datawedge.db` or a profile file, `dwprofile_x.db`. If the file is found, it imports the file to replace any existing configuration or profile.

✓ **NOTE:** A Factory Reset deletes all files in the Enterprise folder.

### Auto Import

DataWedge supports remote deployment of a configuration to a device, using tools such as MSP. DataWedge monitors the `/enterprise/device/settings/datawedge/autoimport` folder for the DataWedge configuration file (`datawedge.db`) or a profile file (`dwprofile_x.db`). When DataWedge launches it checks the folder. If a configuration or profile file is found, it imports the file to replace any existing configuration or profile. Once the file has been imported it is deleted from the folder.

While DataWedge is running it receives a notification from the system that a file has been placed into the `/enterprise/device/settings/datawedge/autoimport` folder. When this occurs, DataWedge imports this new configuration or profile, replacing the existing one and delete the file. DataWedge begins using the imported configuration immediately.

✓ **NOTE:** A Factory Reset deletes all files in the Enterprise folder.

It is strongly recommended that the user exits DataWedge before remotely deploying any configuration or profile. It is required that the file permissions are set to 666.

---

## Programming Notes

The following paragraphs provide specific programming information when using DataWedge.

### Overriding Trigger Key in an Application

To override the trigger key in an application, create a profile for the application that disables the Barcode input. In the application, use standard APIs, such as `onKeyDown()` to listen for the `KEYCODE_BUTTON_L1` and `KEYCODE_BUTTON_R1` presses.



### Capture Data and Taking a Photo in the Same Application

To be able to capture bar code data and take a photo in the same application:

- Create a Datawedge profile pertaining to the picture taking Activity in your application that disables scanning and use standard Android SDK APIs to control the Camera.
- The default Datawedge profile takes care of the scanning in the application. You might want to create another DataWedge profile that caters to any specific scanning needs, associated to your Application's Activity pertaining to scanning.

### Disable DataWedge on Device and Mass Deploy

To disable DataWedge and deploy onto multiple devices:

1. Swipe up from the bottom of the Home screen and touch .
2. Touch .
3. Touch **Settings**.
4. Unselect the **DataWedge enabled** check box.
5. Export the DataWedge configuration. See [Exporting a Configuration File on page 138](#) for instructions. See [Configuration and Profile File Management on page 139](#) for instructions for using the auto import feature.

### DataWedge APIs

DataWedge APIs operate primarily through Android intents - specific commands that can be used by other applications to control data capture without the need to directly access the DataWedge UI.

### Reporting

DataWedge 6.6 (and higher) can report the results of the importation of device Profiles. These HTML reports display settings differences between the originating (source) database and the target (destination) device. This allows administrators to easily identify differences and make adjustments to compensate for disparities in hardware or software capabilities from one device to another. Reports always use the destination device as the basis against which to compare incoming settings files.

### Soft Scan Feature

DataWedge allows a native Android application to programmatically start, stop, or toggle the scan trigger state. The application can issue an Android Broadcast Intent, to control the scanner, without requiring the scan key to be pressed. The active DataWedge profile is required to control all the parameters during a scan operation.

The structure of the broadcast intent that resolves to the soft scan is:

**action:** "com.symbol.emdk.datawedge.api.ACTION\_SOFTSCANTRIGGER"

**extras:** This is a String name/value pair that contains trigger state details.

**name:** "com.symbol.emdk.datawedge.api.EXTRA\_PARAMETER"

**value:** "START\_SCANNING" or "STOP\_SCANNING" or "TOGGLE\_SCANNING"

## Sample

```
Intent sendIntent = new Intent();
sendIntent.setAction("com.symbol.emdk.datawedge.api.ACTION_SOFTSCANTRIGGER");
sendIntent.putExtra("com.symbol.emdk.datawedge.api.EXTRA_PARAMETER",
"TOGGLE_SCANNING");
sendBroadcast(sendIntent);
```

## Scanner Input Plugin

The ScannerInputPlugin API command can be used to enable/disable the scanner plug-in being used by the currently active Profile. Disabling the scanner plug-in effectively disables scanning in that Profile, regardless of whether the Profile is associated or unassociated. Valid only when Barcode Input is enabled in the active Profile.



**NOTE:** Use of this API changes only the runtime status of the scanner; it does not make persistent changes to the Profile.

## Function Prototype

```
Intent i = new Intent();
i.setAction(ACTION);
i.putExtra(EXTRA_DATA, "<parameter>");
```

## Parameters

**action:** String "com.symbol.datawedge.api.ACTION\_SCANNERINPUTPLUGIN"

**extra\_data:** String "com.symbol.datawedge.api.EXTRA\_PARAMETER"

**<parameter>:** The parameter as a string, using either of the following:

- "ENABLE\_PLUGIN" - enables the plug-in
- "DISABLE\_PLUGIN" - disables the plug-in

## Return Values

None.

Error and debug messages will be logged to the Android logging system which then can be viewed and filtered by the logcat command. You can use logcat from an ADB shell to view the log messages, e.g.

```
$ adb logcat -s DWAPI
```

Error messages will be logged for invalid actions and parameters.

## Example

```
// define action and data strings
String scannerInputPlugin = "com.symbol.datawedge.api.ACTION_SCANNERINPUTPLUGIN";
String extraData = "com.symbol.datawedge.api.EXTRA_PARAMETER";

public void onResume() {
    // create the intent
    Intent i = new Intent();
    // set the action to perform
    i.setAction(scannerInputPlugin);
    // add additional info
    i.putExtra(extraData, "DISABLE_PLUGIN");
    // send the intent to DataWedge
    context.this.sendBroadcast(i);
}
```

## Comments

This Data Capture API intent allows the scanner plug-in for the current Profile to be enabled or disabled. For example, activity A launches and uses the Data Capture API intent to switch to ProfileA in which the scanner plug-in is enabled, then at some point it uses the Data Capture API to disable the scanner plug-in. Activity B is launched. In DataWedge, ProfileB is associated with activity B. DataWedge switches to ProfileB. When activity A comes back to the foreground, in the `onResume` method, activity A needs to use the Data Capture API intent to switch back to ProfileA, then use the Data Capture API intent again to disable the scanner plug-in, to return back to the state it was in.



**NOTE:** Use of this API changes only the runtime status of the scanner; it does not make persistent changes to the Profile.

The above assumes that ProfileA is not associated with any applications/activities, therefore when focus switches back to activity A, DataWedge will not automatically switch to ProfileA therefore activity A must switch back to ProfileA in its `onResume` method. Because DataWedge will automatically switch Profile when an activity is paused, it is recommended that this API function be called from the `onResume` method of the activity.

## Enumerate Scanners

Use the `enumerateScanners` API command to get a list of scanners available on the device.

### Function Prototype

```
Intent i = new Intent();
i.setAction(ACTION);
```

### Parameters

**action:** String "com.symbol.datawedge.api.ACTION\_ENUMERATESCANNERS"

## Return Values

The enumerated list of scanners will be returned via a broadcast Intent. The broadcast Intent action is "com.symbol.datawedge.api.ACTION\_ENUMERATEDSCANNERLIST" and the list of scanners is returned as a string array (see the example below).

Error and debug messages will be logged to the Android logging system which then can be viewed and filtered by the logcat command. You can use logcat from an ADB shell to view the log messages, e.g.

```
$ adb logcat -s DWAPI
```

Error messages will be logged for invalid actions and parameters

## Example

```
// first send the intent to enumerate the available scanners on the device
// define action string
String enumerateScanners = "com.symbol.datawedge.api.ACTION_ENUMERATESCANNERS";
// create the intent
Intent i = new Intent();
// set the action to perform
i.setAction(enumerateScanners);
// send the intent to DataWedge
context.this.sendBroadcast(i);

// now we need to be able to receive the enumerate list of available scanners
String enumeratedList = "com.symbol.datawedge.api.ACTION_ENUMERATEDSCANNERLIST";
String KEY_ENUMERATEDSCANNERLIST = "DataWedgeAPI_KEY_ENUMERATEDSCANNERLIST";
// Create a filter for the broadcast intent
IntentFilter filter = new IntentFilter();
filter.addAction(enumeratedList);
registerReceiver(myBroadcastReceiver, filter);

// now we need a broadcast receiver
private BroadcastReceiver myBroadcastReceiver = new BroadcastReceiver() {
    @Override
    public void onReceive(Context context, Intent intent) {
        String action = intent.getAction();
        if (action.equals(enumeratedList)) {
            Bundle b = intent.getExtras();
            String[] scanner_list = b.getStringArray(KEY_ENUMERATEDSCANNERLIST);
        }
    }
};
```

## Comments

The scanner and its parameters are set based on the currently active Profile.

## Set Default Profile

Use the `setDefaultProfile` API function to set the specified Profile as the default Profile.

### Default Profile Recap

Profile0 is the generic Profile used when there are no user created Profiles associated with an application.

Profile0 can be edited but cannot be associated with an application. That is, DataWedge allows manipulation of plug-in settings for Profile0 but it does not allow assignment of a foreground application. This configuration allows DataWedge to send output data to any foreground application other than applications associated with user-defined Profiles when Profile0 is enabled.

Profile0 can be disabled to allow DataWedge to only send output data to those applications which are associated in user-defined Profiles. For example, create a Profile associating a specific application, disable Profile0 and then scan. DataWedge only sends data to the application specified in the user-created Profile. This adds additional security to DataWedge enabling the sending of data only to specified applications.

### Usage Scenario

A launcher application has a list of apps that a user can launch and that none of the listed apps has an associated DataWedge Profile. Once the user has selected an app, the launcher needs to set the appropriate DataWedge Profile for the selected app. This could be done by using `setDefaultProfile` to set the default Profile to the required Profile. Then when the user launches the selected app, DataWedge auto Profile switching switches to the default Profile (which is now the required Profile for that app).

If, for some reason, the launched app has an associated DataWedge Profile then that will override the set default Profile.

When control is returned to the launcher application, `resetDefaultProfile` can be used to reset the default Profile.

### Function Prototype

```
Intent i = new Intent();
i.setAction(ACTION);
i.putExtra(EXTRA_DATA, "<profile name>");
```

### Parameters

**action:** String "com.symbol.datawedge.api.ACTION\_SETDEFAULTPROFILE"

**extra\_data:** String "com.symbol.datawedge.api.EXTRA\_PROFILENAME"

**<profile name>:** The Profile name to set as the default Profile as a string (case-sensitive).

### Return Values

None.

Error and debug messages will be logged to the Android logging system which then can be viewed and filtered by the logcat command. You can use logcat from an ADB shell to view the log messages, e.g.



```
$ adb logcat -s DWAPI
```

Error messages will be logged for invalid actions, parameters and failures (e.g. Profile not found or associated with an application).

### Example

```
// define action and data strings
String setDefaultProfile = "com.symbol.datawedge.api.ACTION_SETDEFAULTPROFILE";
String extraData = "com.symbol.datawedge.api.EXTRA_PROFILENAME";

public void onResume() {
    // create the intent
    Intent i = new Intent();
    // set the action to perform
    i.setAction(setDefaultProfile);
    // add additional info
    i.putExtra(extraData, "myProfile");
    // send the intent to DataWedge
    context.this.sendBroadcast(i);
}
```

### Comments

The API command will have no effect if the specified Profile does not exist or if the specified Profile is already associated with an application. DataWedge will automatically switch Profiles when the activity is paused, so it is recommended that this API function be called from the onResume method of the activity.

Zebra recommends that this Profile be created to cater to all applications/activities that would otherwise default to using Profile0. This will ensure that these applications/activities continue to work with a consistent configuration.

## Reset Default Profile

Use the resetDefaultProfile API function to reset the default Profile back to Profile0.

### Function Prototype

```
Intent i = new Intent();

i.setAction(ACTION);
i.putExtra(EXTRA_DATA, "<Profile name>");
```

### Parameters

**action:** String "com.symbol.datawedge.api.ACTION\_RESETPROFILE"

**extra\_data:** String "com.symbol.datawedge.api.EXTRA\_PROFILENAME"

**<Profile name>:** The Profile name to set as the default Profile as a string (case-sensitive).

### Return Values

None.

Error and debug messages will be logged to the Android logging system which then can be viewed and filtered by the logcat command. You can use logcat from an ADB shell to view the log messages, e.g.

```
$ adb logcat -s DWAPI
```

Error messages will be logged for invalid actions, parameters and failures (e.g. Profile not found or associated with an application).

### Example

```
// define action string
String resetDefaultProfile = "com.symbol.datawedge.api.ACTION_RESETPROFILE";

public void onResume() {
    // create the intent
    Intent i = new Intent();
    // set the action to perform
    i.setAction(resetDefaultProfile);
    context.this.sendBroadcast(i);
}
```

### Comments

None.

## Switch To Profile

Use the SwitchToProfile API action to switch to the specified Profile.

### Profiles Recap

DataWedge is based on Profiles and plug-ins. A Profile contains information on how DataWedge should behave with different applications.

Profile information consists of:

- Associated application
- Input plug-in configurations
- Output plug-in configurations
- Process plug-in configurations

DataWedge includes a default Profile, Profile0, that is created automatically the first time DataWedge runs.

Using Profiles, each application can have a specific DataWedge configuration. For example, each user application can have a Profile which outputs scanned data in the required format when that application comes to the foreground. DataWedge can be configured to process the same set of captured data differently based on the requirements of each application.



**NOTE:** Use of this API changes only the runtime status of the scanner; it does not make persistent changes to the Profile.

### NOTE

A single Profile may be associated with one or many activities/apps, however, given an activity, only one Profile may be associated with it.

### Usage Scenario

An application has two activities. Activity A only requires EAN13 bar codes to be scanned. Activity B only requires Code 128 bar codes to be scanned. Profile EAN13 is configured to only scan EAN13 bar codes and is left unassociated. Profile Code128 is configured to scan Code 128 and is left unassociated. When Activity A launches it uses SwitchToProfile to activate Profile EAN13. Similarly, when Activity B launches it uses switchToProfile to activate Profile Code128.

If another activity/app comes to the foreground, DataWedge auto Profile switching will set the DataWedge Profile accordingly either to the default Profile or to an associated Profile.

When Activity A (or Activity B) comes back to the foreground it will use switchToProfile to reset the Profile back to Profile B (or Profile M).

### Function Prototype

```
Intent i = new Intent();
i.setAction(ACTION);
i.putExtra(EXTRA_DATA, "<profile name>");
```

### Parameters

**action:** String "com.symbol.datawedge.api.ACTION\_SWITCHTOPROFILE"

**extra\_data:** String "com.symbol.datawedge.api.EXTRA\_PROFILENAME"

**<profile name>:** The Profile name to switch to as a string (case-sensitive).

## Return Values

None.

Error and debug messages will be logged to the Android logging system which then can be viewed and filtered by the logcat command. You can use logcat from an ADB shell to view the log messages, e.g.

```
$ adb logcat -s DWAPI
```

Error messages will be logged for invalid actions, parameters and failures (e.g. Profile not found or associated with an application).

## Example

```
// define action and data strings
String switchToProfile = "com.symbol.datawedge.api.ACTION_SWITCHTOPROFILE";
String extraData = "com.symbol.datawedge.api.EXTRA_PROFILENAME";

public void onResume() {
    super.onResume();
    // create the intent
    Intent i = new Intent();
    // set the action to perform
    i.setAction(switchToProfile);
    // add additional info
    i.putExtra(extraData, "myProfile");
    // send the intent to DataWedge
    context.this.sendBroadcast(i);
}
```

## Comments

This API function will have no effect if the specified Profile does not exist or is already associated with an application.

DataWedge has a one-to-one relationship between Profiles and activities; a Profile can be associated only with a single activity. When a Profile is first created, it's not associated with any application, and will not be activated until associated. This makes it possible to create multiple unassociated Profiles.

This API function activates such Profiles.

For example, Profile A is unassociated and Profile B is associated with activity B. If activity A is launched and uses **SwitchToProfile** function to switch to Profile A, then Profile A will be active whenever activity A is in the foreground. When activity B comes to the foreground, DataWedge will automatically switch to Profile B.

When activity A returns to the foreground, the app must use **SwitchToProfile** again to switch back to Profile A. This would be done in the **onResume** method of activity A.



**NOTE:** Use of this API changes only the runtime status of the scanner; it does not make persistent changes to the Profile.

## Notes

Because DataWedge will automatically switch Profile when the activity is paused, Zebra recommends that this API function be called from the onResume method of the activity.

After switching to a Profile, this unassociated Profile does not get assigned to the application/activity and is available to be used in the future with a different app/activity.

For backward compatibility, DataWedge's automatic Profile switching is not affected by the above API commands. This why the commands work only with unassociated Profiles and apps.

DataWedge auto Profile switching works as follows:

Every second...

- Sets newProfileId to the associated Profile ID of the current foreground activity.
- If no associated Profile is found, sets newProfileId to the associated Profile ID of the current foreground app.
- If no associated Profile is found, sets newProfileId to the current default Profile (which MAY NOT be Profile0).
- Checks the newProfileId against the currentProfileId. If they are different:
  - deactivates current Profile
  - activates new Profile (newProfileId)
  - sets currentProfileId = newProfileId

## Imager as Camera

Use the standard Android SDK Camera API functions to operate the imager scanner as a camera. When using the imager scanner as a camera, the following Camera API functions are supported:

- **Camera.open(ID)** - Set ID to 100 to open the Imager Scanner as a camera instance.
- **Camera.release()** - Release the Imager Scanner opened using camera API.
- **Camera.setPreviewDisplay(surfaceHolder)** - Add SurfaceView via SurfaceHolder to show preview.
- **Camera.SetPreviewCallback(PreviewCallback)** - Set previewCallback to get preview data.
- **Camera.startPreview()** - Starting Imager Scanner preview via SurfaceView.
- **Camera.stopPreview()** - Stopping Imager Scanner preview showing in SurfaceView.
- **Camera.getCameraInfo(CameraID, CameraInfo)** - Get camera information on camera ID. CameraInfo has the following members:
  - orientation
  - facing
  - canDisableShutterSound

Use the Zebra Mx architecture to decode barcodes with the imager scanner when the imager as camera feature is disabled. When the imager as camera feature is enabled the imager can not decode barcodes and capture images at the same time.



# Settings

---

## Introduction



This chapter describes settings available for configuring the device.

---

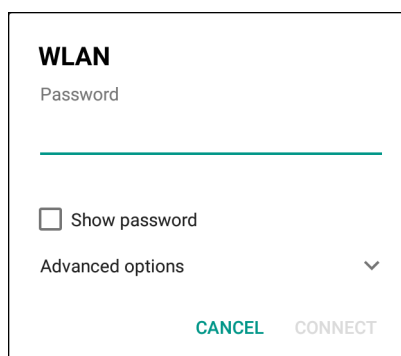
## WLAN Configuration


### Configuring a Wi-Fi Network

To set up a Wi-Fi network:

1. Swipe down with two fingers from the status bar to open the quick access panel and then touch .
2. Touch  **Wi-Fi**.
3. Slide the switch to the **ON** position.
4. The device searches for WLANs in the area and lists them on the screen.
5. Scroll through the list and select the desired WLAN network.
6. Touch the desired network. If the network security is **Open**, the device automatically connects to the network. For all other network security a dialog box appears.

**Figure 104** WLAN WEP Network Security Dialog Box



**WLAN**  
Password  
\_\_\_\_\_  
 Show password  
Advanced options   
CANCEL CONNECT

**Figure 105** WLAN 802.11 EAP Network Security Dialog Box

7. If the network security is **WEP** or **WPA/WPS2 PSK**, enter the required password and then touch **Connect**.
8. If the network security is 802.1x EAP:
  - Touch the **EAP method** drop-down list and select **PEAP**, **TLS**, **TTLS** or **LEAP**.
  - Touch the **Phase 2 authentication** drop-down list and select an authentication method.
  - If required, touch **CA certificate** and select a Certification Authority (CA) certificate. Note: Certificates are installed using the **Security** settings.
  - If required, touch **User certificate** and select a user certificate. Note: User certificates are installed using the **Security** settings.
  - If required, in the **Identity** text box, enter the username credentials.
  - If desired, in the **Anonymous identity** text box, enter an anonymous identity username.
  - If required, in the **Password** text box, enter the password for then given identity.



**NOTE:** By default, the network Proxy is set to **None** and the IP settings is set to **DHCP**. See [Configuring for a Proxy Server on page 153](#) for setting connection to a proxy server and see [Configuring the Device to Use a Static IP Address on page 154](#) for setting the device to use a static IP address.




9. Touch **Connect**.
10. Touch

## Manually Adding a Wi-Fi Network

Manually add a Wi-Fi network if the network does not broadcast its name (SSID) or to add a Wi-Fi network when out of range.

1. Swipe down with two fingers from the status bar to open the quick access panel and then touch



2. Touch  **Wi-Fi**.
  3. Slide the Wi-Fi switch to the **On** position.
  4. Scroll to the bottom of the list and select **Add network**.
  5. In the **Network SSID** text box, enter the name of the Wi-Fi network.
  6. In the **Security** drop-down list, select the type of security. Options:
    - **None**
    - **WEP**
    - **WPA/WPA2 PSK**
    - **802.1x EAP**.
  7. If the network security is **None**, touch **Save**.
  8. If the network security is **WEP** or **WPA/WPA2 PSK**, enter the required password and then touch **Save**.
  9. If the network security is **802.1x EAP**:
    - Touch the **EAP method** drop-down list and select **PEAP, TLS, TTLS** or **LEAP**.
    - Touch the **Phase 2 authentication** drop-down list and select an authentication method.
    - If required, touch **CA certificate** and select a Certification Authority (CA) certificate. Note: Certificates are installed using the **Security** settings.
    - If required, touch **User certificate** and select a user certificate. Note: User certificates are installed using the **Security** settings.
    - If required, in the **Identity** text box, enter the username credentials.
    - If desired, in the **Anonymous** identity text box, enter an anonymous identity username.
    - If required, in the **Password** text box, enter the password for then given identity.
-  **NOTE:** By default, the network Proxy is set to **None** and the IP settings is set to **DHCP**. See [Configuring for a Proxy Server on page 153](#) for setting connection to a proxy server and see [Configuring the Device to Use a Static IP Address on page 154](#) for setting the device to use a static IP address.
10. Touch **Save**. To connect to the saved network, touch and hold on the saved network and select **Connect to network**.
  11. Touch .

## Configuring for a Proxy Server

A proxy server is a server that acts as an intermediary for requests from clients seeking resources from other servers. A client connects to the proxy server, requesting some service, such as a file, connection, web page, or other resource, available from a different server. The proxy server evaluates the request according to its filtering rules. For example, it may filter traffic by IP address or protocol. If the request is validated by the filter, the proxy provides the resource by connecting to the relevant server and requesting the service on behalf of the client.

It is important for enterprise customers to be able to set up secure computing environments within their companies, and proxy configuration is an essential part of doing that. Proxy configuration acts as a security barrier ensuring that the proxy server monitors all traffic between the Internet and the intranet. This is normally an integral part of security enforcement in corporate firewalls within intranets.

1. In the network dialog box, touch a network.
2. Touch **Advanced options**.
3. Touch **Proxy** and select **Manual**.

Figure 106 Proxy Settings

**WLAN**

Proxy  
Manual

The HTTP proxy is used by the browser but may not be used by the other apps.

Proxy hostname  
proxy.example.com

Proxy port  
8080

Bypass proxy for  
example.com,mycomp.test.com,|

IP settings  
Static

IP address  
192.168.1.128

CANCEL CONNECT

4. In the **Proxy hostname** text box, enter the address of the proxy server.
5. In the **Proxy port** text box, enter the port number for the proxy server.  
When entering a proxy address in the Bypass proxy for field, do not use spaces or carriage returns between addresses.
6. In the **Bypass proxy for** text box, enter addresses for web sites that do not require to go through the proxy server. Use a comma “,” between addresses.
7. Touch **Connect**.
8. Touch .

## Configuring the Device to Use a Static IP Address

By default, the device is configured to use Dynamic Host Configuration Protocol (DHCP) to assign an Internet protocol (IP) address when connecting to a wireless network. To configure the device to connect to a network using a static IP address:

1. In the network dialog box, touch a network.
2. Touch **Advanced options**.
3. Touch **IP settings** and select **Static**.

**Figure 107** Static IP Settings

**WLAN**

IP settings  
Static

IP address  
192.168.1.128

Gateway  
192.168.1.1

Network prefix length  
24

DNS 1  
8.8.8.8

DNS 2  
8.8.4.4

CANCEL CONNECT

4. In the **IP address** text box, enter an IP address for the device.
5. If required, in the **Gateway** text box, enter a gateway address for the device.
6. If required, in the **Network prefix length** text box, enter a the prefix length.
7. If required, in the **DNS 1** text box, enter a Domain Name System (DNS) address.
8. If required, in the **DNS 2** text box, enter a DNS address.
9. Touch **Connect**.
10. Touch .

## Advanced Wi-Fi Settings



**NOTE:** Advanced Wi-Fi settings are for the device not for a specific wireless network.

Use the **Advanced** settings to configure advanced Wi-Fi settings. From the **Wi-Fi** screen, touch **⋮** > **Advanced** to view the advanced settings.

- **Install Certificates** – Touch to install certificates.
- **Wi-Fi Direct** - Displays a list of devices available for a direct Wi-Fi connection.
- **WPS Push Button** - Touch to connect to a network using Wi-Fi Protected Setup (WPS) push button method.
- **WPS Pin Entry** - Touch to connect to a network using Wi-Fi Protected Setup (WPS) pin entry method.

## Additional Wi-Fi Settings

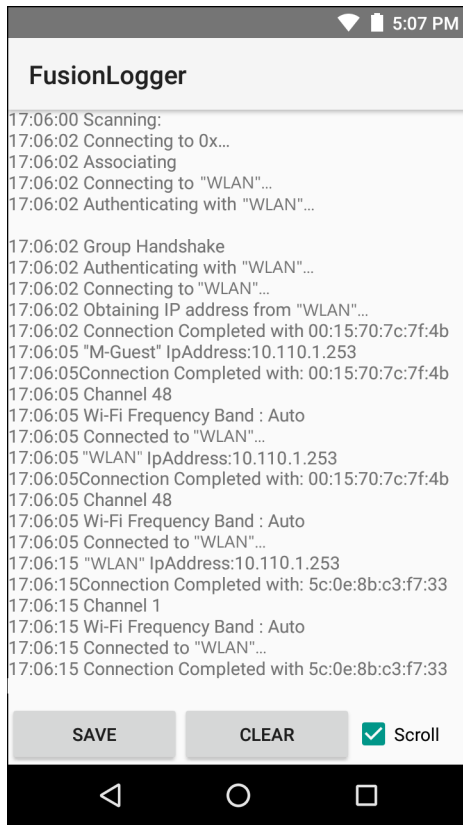


**NOTE:** Additional Wi-Fi settings are for the device not for a specific wireless network.

Use the **Additional Settings** to configure additional Wi-Fi settings. From the **Wi-Fi** screen, touch **⋮** > **Additional settings** to view the additional Wi-Fi settings.

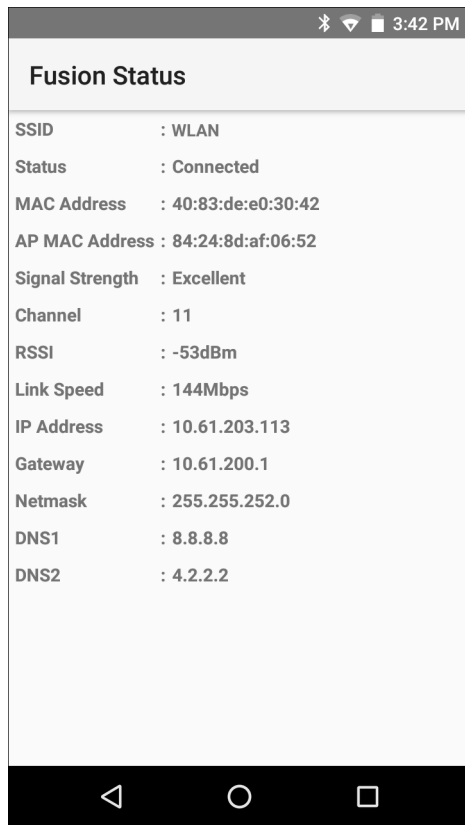
- **Regulatory**
  - **Country selection** - Displays the acquired country code if 802.11d is enabled else it displays the currently selected country code.
  - **Region code** - Displays the current region code.
- **Band and Channel Selection**
  - **Wi-Fi frequency band** - Use to select the frequency band. Options: **Auto** (default), **5 GHz only** or **2.4 GHz only**.
  - **Available channels (2.4 GHz)** - Use to select specific channels. Touch to display the **Available channels** menu. Select specific channels. Touch **OK**.
  - **Available channels (5 GHz)** - Use to select specific channels. Touch to display the **Available channels** menu. Select specific channels. Touch **OK**.
- **Logging**
  - **Advanced Logging** – Touch to enable advanced logging. Advanced logging
  - **Wireless logs** - Use to capture Wi-Fi log files.
    - **Fusion Logger** - Touch to open the **Fusion Logger** application. This application maintains a history of high level WLAN events which helps to understand the status of connectivity.

Figure 108 Fusion Logger Screen



- **Fusion Status** - Touch to display live status of WLAN state. Also provides information of device and connected profile.

Figure 109 Fusion Status Screen





- **About**
  - **Version** - Displays the current Fusion information.

---

## Screen Unlock Settings

Use the **Security settings** to set preferences for locking the screen.

1. Swipe down with two fingers from the status bar to open the quick access panel and then touch .
2. Touch  **Security**.

✓ **NOTE:** Options vary depending upon the application's policy, for example, email.

- **Screen lock** - Touch to configure the device to require a slide, pattern, PIN, or password to unlock the screen.
  - **None** - Disable screen unlock security.
  - **Swipe** - Slide the lock icon to unlock the screen.
  - **Pattern** - Draw a pattern to unlock screen. See Set Screen Unlock Using Pattern for more information.
  - **PIN** - Enter a numeric PIN to unlock screen. See Set Screen Unlock Using PIN for more information.
  - **Password** - Enter a password to unlock screen. See Set Screen Unlock Using Password for more information.



Lock the screen to protect access to data on the device. Some email accounts require locking the screen. The Locking feature functions differently in Single-user versus Multiple-user mode.

When locked, a slide, pattern, PIN or password is required to unlock the device. Press the Power button to lock the screen. The device also locks after a pre-defined time-out.

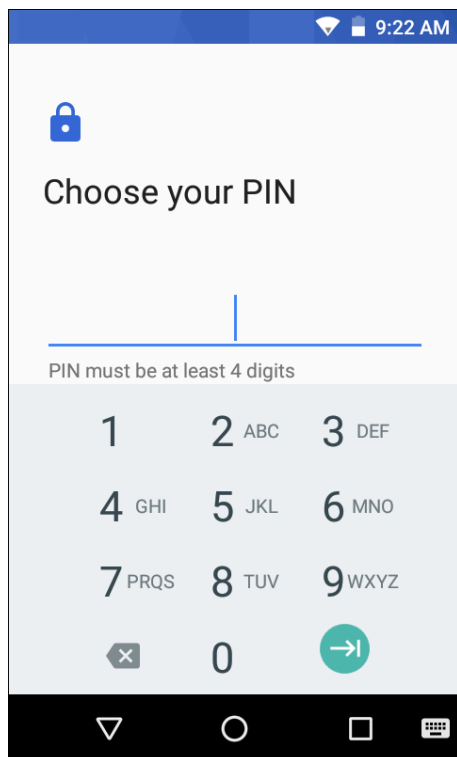
Press and release the Power button to wake the device. The Lock screen displays.


Slide the screen up to unlock. If the Pattern screen unlock feature is enabled, the Pattern screen appears instead of the Lock screen. If the PIN or Password screen unlock feature is enabled, enter the PIN or password after unlocking the screen.

## Set Screen Unlock Using PIN

1. Swipe down with two fingers from the status bar to open the quick access panel and then touch .
2. Touch  **Security**.
3. Touch **Screen lock**.
4. Touch **PIN**.
5. To require a PIN upon device start up select **Require PIN to start device** or **No thanks** not to require a PIN.

**Figure 110** PIN Screen



6. Touch in the text field.
7. Enter a PIN (4 numbers) then touch **Continue**.
8. Re-enter PIN and then touch **OK**.
9. Select the type of notifications that appear when the screen is locked and then touch **Done**.
10. Touch . The next time the device goes into suspend mode a PIN is required upon waking.

## Set Screen Unlock Using Password



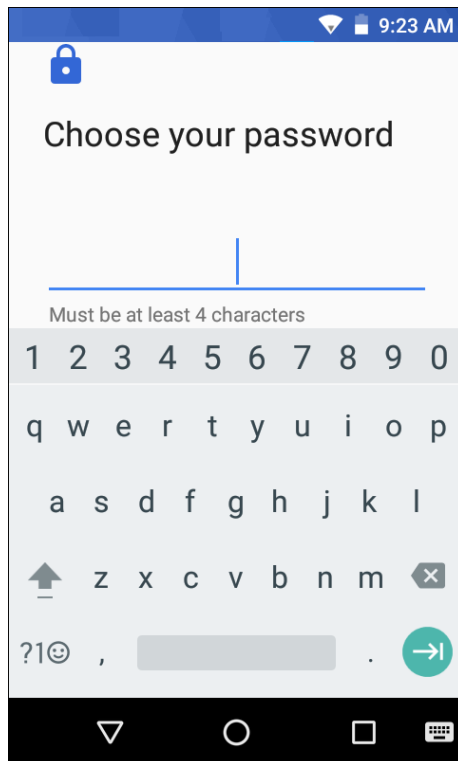



1. Swipe down with two fingers from the status bar to open the quick access panel and then touch .
2. Touch  **Security**.
3. Touch **Screen lock**.
4. Touch **Password**.
5. To require a password upon device start up select **Require password to start device** or **No thanks** not to require a PIN.
6. Touch in the text field.

Figure 111 Password Screen

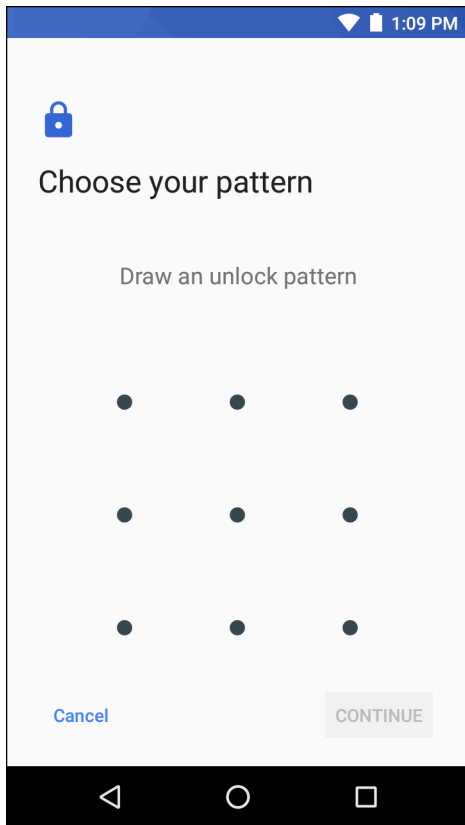



7. Enter a password (between 4 and 16 characters) then touch **Continue**.
8. Re-enter the password and then touch **OK**.
9. Select the type of notifications that appear when the screen is locked and then touch **Done**.
10. Touch . The next time the device goes into suspend mode a password is required upon waking.

## Set Screen Unlock Using Pattern

1. Swipe down with two fingers from the status bar to open the quick access panel and then touch .
2. Touch  **Security**.
3. Touch **Screen lock**.
4. Touch **Pattern**.
5. To require a password upon device start up select **Require password to start device** or **No thanks** not to require a PIN.





**Figure 112** Choose Your Pattern Screen

6. Draw a pattern connecting at least four dots.
7. Touch **Continue**.
8. Re-draw the pattern.
9. Touch **Confirm**.
10. Select the type of notifications that appear when the screen is locked and then touch **Done**.
11. Touch . The next time the device goes into suspend mode a Pattern is required upon waking.

---

## Passwords

To set the device to briefly show password characters as the user types:

Swipe down with two fingers from the status bar to open the quick access panel and then touch  >  **Security**. Slide the **Make passwords visible** switch to the ON position.

---



## Button Remapping

The MC33XX's buttons can be programmed to perform different functions or shortcuts to installed applications.

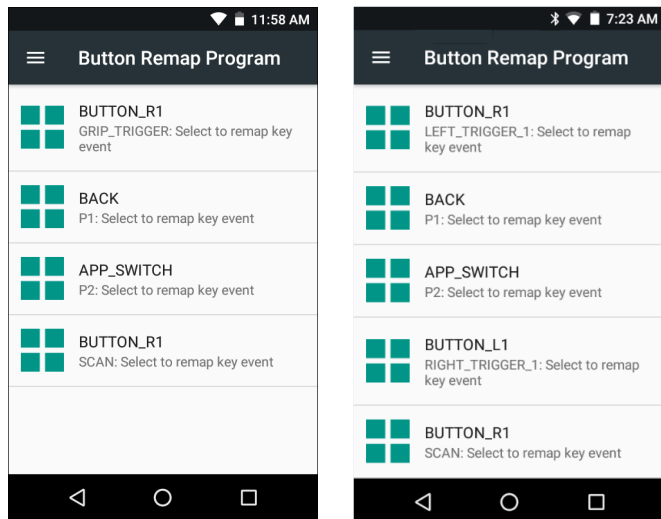
- ✓ **NOTE:** It is not recommended to remap the scan button.
  - Grip Trigger

- P1 Button
- P2 Button
- Scan Button

## Remapping a Button

1. Swipe down with two fingers from the status bar to open the quick access panel and then touch .
2. Touch  **Key Programmer**.

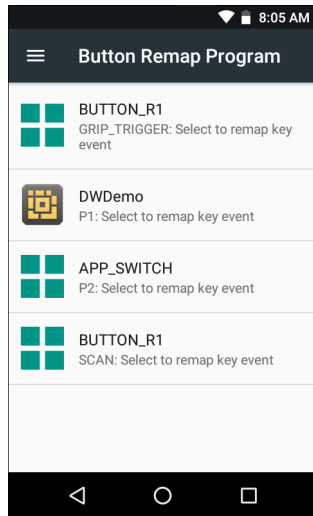
**Figure 113** Key Programmer Screen



3. Select the button to remap.
4. Touch the **BUTTON REMAPPING** tab or the **SHORTCUT** tab that lists the available functions and applications.
5. Touch a function or application shortcut to map to the button.

✓ **NOTE:** If you select an application shortcut, the application icon appears next to the button on the Key Programmer screen.

Figure 114 Remapped Button



6. Touch .

---

## Accounts

Use the **Accounts** settings to add, remove, and manage accounts. Use these settings to control how applications send, receive, and sync data on their own schedules, and whether applications can synchronize user data automatically.



Applications may also have their own settings to control how they synchronize data; see the documentation for those applications for details.

---


## Language Usage

Use the **Language & input** settings to change the language that display for the text and including words added to its dictionary.

### Changing the Language Setting

1. Swipe down with two fingers from the status bar to open the quick access panel and then touch .
2. Touch  **Language & input**.
3. Touch **Language**, select a language from the list of available languages.  
The operating system text changes to the selected language.

### Adding Words to the Dictionary

1. In the **Language & input** screen, touch **Personal dictionary**.
2. If prompted, select the language that this word or phrase is stored.
3. Touch **+** to add a new word or phrase to the dictionary.
4. Enter the word or phrase.
5. In the **Shortcut** text box, enter a shortcut for the word or phrase.
6. Touch .



---

## Keyboard Settings

Use the **Language & input** settings for configuring the on-screen keyboards. The device contains the following keyboard settings:

- Android Keyboard - Available on MC33XX with AOSP build.
- Google Keyboard - Available on MC33XX with GMS build.
- Enterprise Keyboard - Available on AOSP and GMS builds, if enabled.

To enable the Enterprise Keyboard:

- i. Swipe down with two fingers from the status bar to open the quick access panel and then touch .
- ii. Touch  **Language & input**.
- iii. Touch **Virtual keyboard**.
- iv. Touch **Manage keyboards**.
- v. Slide the **Enterprise keyboard** switch to the On position to enable.

---

## PTT Express Configuration

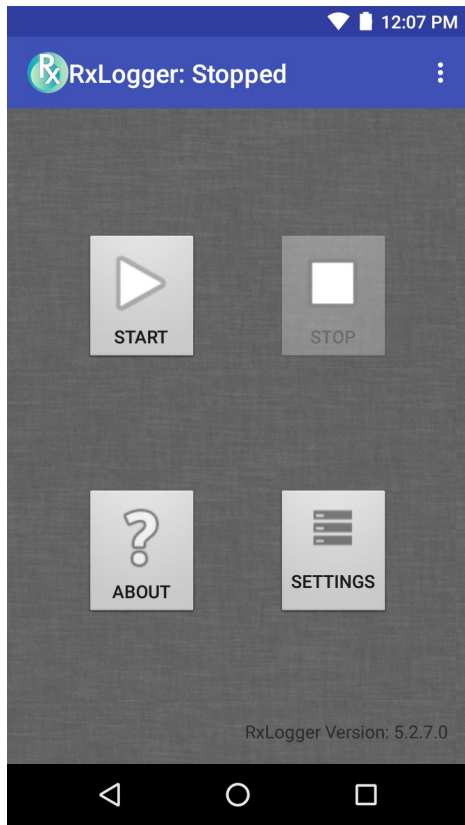
Refer to the PTT Express User Guide at [www.zebra.com/support](http://www.zebra.com/support) for information on configuring the PTT Express Client application.

---

## RxLogger

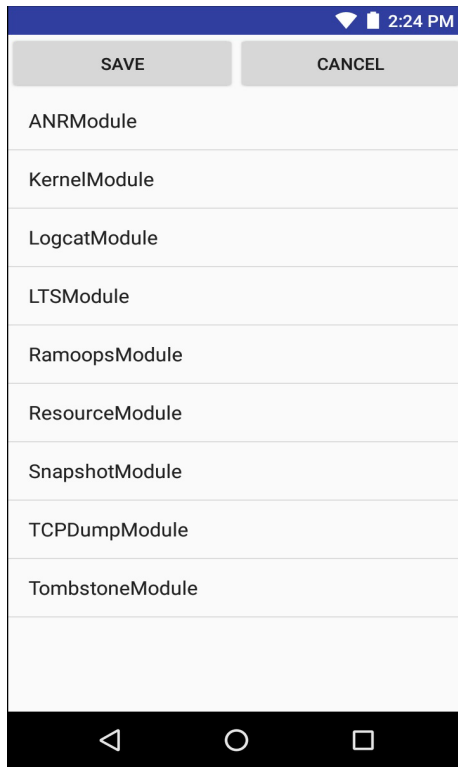
RxLogger is a comprehensive diagnostic tool that provides application and system metrics. It allows for custom plug-ins to be created and work seamlessly with this tool. RxLogger is used to diagnose device and application issues. Its information tracking includes the following: CPU load, memory load, memory snapshots, battery consumption, power states, wireless logging, cellular logging, TCP dumps, Bluetooth logging, GPS logging, logcat, FTP push/pull, ANR dumps, etc. All logs and files generated are saved onto flash storage on the device (internal or external).

Figure 115 RxLogger



## RxLogger Configuration

RxLogger is built with an extensible plug-in architecture and comes packaged with a number of plug-ins already built-in. The included plug-ins are described below. Touch **Settings** to open the configuration screen.

**Figure 116** RxLogger Configuration Screen

## ANR Module

Application Not Responsive (ANR) indicates that a running application's UI thread is not responding for a specified time period. RxLogger is able to detect this condition and trigger a copy of the call stack trace of the unresponsive application into the log directory. The event will also be indicated in the high level CSV log.

- **Enable Module** - Enables logging for this module.
- **Log path** - Specifies the default log path to store the ANR log files.
- **Collect Historic ANRs** - Collects ANR trace files from the system.

## Kernal Module

The Kernel Module captures kmsg from the system.

- **Enable Module** - Enables logging for this kernal module.
- **Log path** - Specifies the high level log path for storage of all kernal logs. This setting applies globally to all kernal buffers.
- **Kernel Log filename** - Specifies the base log filename for this kernal buffer. The current file count is appended to this name.
- **Max Kernal log file size** - Specifies the maximum size, in megabytes, of an individual log file.
- **Kernel Log interval** - Sets the interval, in seconds, on which to flush the log buffer to the file.
- **Kernel Log file count** - Specifies the number of log files to keep and rotate through. Each log file is subject to the max log size option.

## Logcat Module

Logcat is an essential debugging tool on Android devices. RxLogger provides the ability to record data from all four of the available logcat buffers. The Logcat plug-in has the ability to collect data from multiple logcat buffers provided by the system. Currently these are the main, event, radio, and system buffers. Each of the settings are available for each buffer independently unless otherwise noted.

- **Enable Module** - Enables logging for this module.
- **Log path** - Specifies the high level log path for storage of all logcat logs. This setting applies globally to all logcat buffers.
- **Enable main logcat** - Enables logging for this logcat buffer.
  - **Main Log interval** - Sets the interval, in seconds, on which to flush the log buffer to the file.
  - **Main Log filename** - Specifies the base log filename for this logcat buffer. The current file count is appended to this name.
  - **Main Log file count** - Specifies the number of log files to keep and rotate through. Each log file is subject to the max log size option.
  - **Main Max log file size** - Specifies the maximum size, in megabytes, of an individual log file.
  - **Main Log Filter** - Custom logcat filter to run on the main buffer.
- **Enable event logcat** - Enables event logging for this logcat buffer.
  - **Event Log interval** - Sets the interval, in milliseconds, on which to flush the log buffer to the file.
  - **Event Log filename** - Specifies the base log filename for this logcat buffer. The current file count is appended to this name.
  - **Event Log file count** - Specifies the number of log files to keep and rotate through. Each log file is subject to the max log size option.
  - **Event Max log file size** - Specifies the maximum size, in kilobytes, of an individual log file.
  - **Event log filter** - Custom logcat filter to run on the event buffer.
- **Enable radio logcat** - Enables logging for this logcat buffer.
  - **Radio log interval** - Sets the interval, in milliseconds, on which to flush the log buffer to the file.
  - **Radio log filename** - Specifies the base log filename for this logcat buffer. The current file count is appended to this name.
  - **Radio log file count** - Specifies the number of log files to keep and rotate through. Each log file is subject to the max log size option.
  - **Radio log File size** - Specifies the maximum size, in kilobytes, of an individual log file.
  - **Radio log Filter** - Custom logcat filter to run on the radio buffer.
- **Enable system logcat** - Enables logging for this logcat buffer.
  - **System log interval** - Sets the interval, in milliseconds, on which to flush the log buffer to the file.
  - **System log filename** - Specifies the base log filename for this logcat buffer. The current file count is appended to this name.
  - **System log file count** - Specifies the number of log files to keep and rotate through. Each log file is subject to the max log size option.
  - **System log file size** - Specifies the maximum size, in kilobytes, of an individual log file.
  - **System log filter** - Custom logcat filter to run on the system buffer.

- **Enable crash logcat** - Enables logging for this crash logcat buffer.
  - **Crash log Interval** - Sets the interval, in milliseconds, on which to flush the log buffer to the file.
  - **Crash log Filename** - Specifies the base log filename for this logcat buffer. The current file count is appended to this name.
  - **Crash log file count** - Specifies the number of log files to keep and rotate through. Each log file is subject to the max log size option.
  - **Crash log file size** - Specifies the maximum size, in kilobytes, of an individual log file.
  - **Crash log filter** - Custom logcat filter to run on the crash buffer.
- **Enable combined logcat** - Enables logging for this logcat buffer.
  - **Enable main buffer** - Enable or disable the addition of the main buffer into the combined logcat file.
  - **Enable event buffer** - Enable or disable the addition of the event buffer into the combined logcat file.
  - **Enable radio buffer** - Enable or disable the addition of the radio buffer into the combined logcat file.
  - **Enable system buffer** - Enable or disable the addition of the system buffer into the combined logcat file.
  - **Enable crash buffer** - Enable or disable the addition of the crash buffer into the combined logcat file.
  - **Combined log filename** - Specifies the base log filename for this logcat buffer. The current file count is appended to this name.
  - **Combined log file count** - Specifies the number of log files to keep and rotate through. Each log file is subject to the max log size option.
  - **Combined log file size** - Specifies the maximum size, in kilobytes, of an individual log file.
  - **Combined log filter** - Custom logcat filter to run on the combined buffer.

### LTS Module

The LTS (Long Term Storage) Module captures data over a long duration of time without losing any data. Whenever a file is done being written to, LTS will then GZ the file and save it in an organize path for later use.

- **Enable Module** - Enables logging for this module.
- **Storage Directory** - Specifies the high level log path for storage of all logcat logs. This setting applies globally to all logcat buffers.

### Ramoops Module

Ramoops Module captures last kmsg from the device.

- **Enable Module** - Enables logging for this module.
- **Log path** - Specifies the high level log path for storage of all ramoops logs. This setting applies globally to all ramoops buffers.
- **Base filename** - Specifies the base log filename for this kernel buffer. The current file count is appended to this name.
- **Ramoops file count** - Specifies the number of log files to keep and rotate through. Each log file is subject to the max log size option.

### Resource Module

The Resource Module captures device information on an interval. The data collected contains system statistics to see the health of device over a period of time.



- **Enable Module** - Enables logging for this module.
- **Log path** - Specifies the high level log path for storage of all resource logs. This setting applies globally to all resource buffers.
- **Resource Log interval** - Sets the interval, in seconds, on which to flush the log buffer to the file.
- **Resource Log file size** - Specifies the maximum size, in megabytes, of an individual log file.
- **Resource Log file count** - Specifies the number of log files to keep and rotate through. Each log file is subject to the max log size option.
- **Power** - Enables or disables the collection of Battery statistics.
- **System Resource** - Enables or disables the collection of System Resource information.
- **Network** - Enables or disables the collection of Network status.
- **Bluetooth** - Enables or disables the collection of Bluetooth information.
- **Light** - Enables or disables the collection of ambient light level.

### Snapshot Module

The Snapshot Module collects detailed device statistics on an interval to see detailed device information.

- **Enable Module** - Enables logging for this module.
- **Log path** - Specifies the base path to use to store the snapshot files
- **Log filename** - Specifies the base filename for all the snapshot files. This file number will be appended to this base filename when saving the snapshot.
- **Log interval** - Specifies the interval, in milliseconds, on which to invoke a detailed snapshot.
- **Snapshot file count** - The maximum number of Snapshot files to keep at any one time.
- **Top** - Enables or disables the running of the “top” command for data collection.
- **CPU Info** - Enables detailed per process CPU logging in the snapshot.
- **Memory Info** - Enables logging of detailed per process memory usage in the snapshot.
- **Battery Info** - Enables logging of detailed power information including battery life, on time, charging, and wake locks.
- **Wake Locks** - Enables or disables the collection of the sys/fs wake\_lock information.
- **Time in State** - Enables or disables the collection of the sys/fs cpufreq for each core.
- **Processes** - Enables dumping the complete process list in the snapshot.
- **Threads** - Enables dumping all processes and their threads in the snapshot.
- **Properties** - Enables dumping of all system properties on the device. This includes build/version information as well as state information.
- **Interfaces** - Enables or disables the running of the “netcfg” command for data collection.
- **IP Routing Table** - Enables or disables the collection of the net route for data collection.
- **Connectivity** - Enables or disables the running of the “dumpsys connectivity” command for data collection.
- **Wifi** - Enables or disables the running of the “dumpsys wifi” command for data collection.
- **File systems** - Enables dumping of the available volumes on the file system and the free storage space for each.
- **Usage stats** - Enables dumping of detailed usage information for each package on the device. This includes the number of starts and duration of each run.

## TCPDump Module

The TCPDump Module captures tcp data that happens over the device's networks.

- **Enable Module** - Enables logging for this module.
- **Log path** - Specifies the location to store the TCPDump output log files.
- **Base filename** - Specifies the base filename to use when storing the TCPDump files. The index number of the current log file will be appended to this filename.
- **Tcpdump file size** - Specifies the maximum file size, in megabytes, for each log file created.
- **Tcpdump file count** - Specifies the number of log files to cycle through when storing the network traces.

## Tombstone Module

The Tombstone Module collects tombstone (Linux Native Crashes) logs from the device.



- **Enable Module** - Enables logging for this module.
- **Log path** - Specifies the location to store the Tombstone output log files.
- **Collect Historic tombstones** -

## Configuration File

RxLogger configuration can be set using an XML file. The `config.xml` configuration file is located on the microSD card in the `RxLogger\config` folder. Copy the file from the device to a host computer using a USB connection. Edit the configuration file and then replace the `.XML` file on the device. There is no need to stop and restart the RxLogger service since the file change is automatically detected.



## Enabling Logging

To enable logging:

1. Swipe the screen up and select .
2. Touch **Start**.
3. Touch .

## Disabling Logging

To disable logging:

1. Swipe the screen up and select .
2. Touch **Stop**.
3. Touch .

## Extracting Log Files

1. Connect the device to a host computer using an USB connection.
2. Using a file explorer, navigate to the `RxLogger` folder.
3. Copy the file from the device to the host computer.
4. Disconnect the device from the host computer.

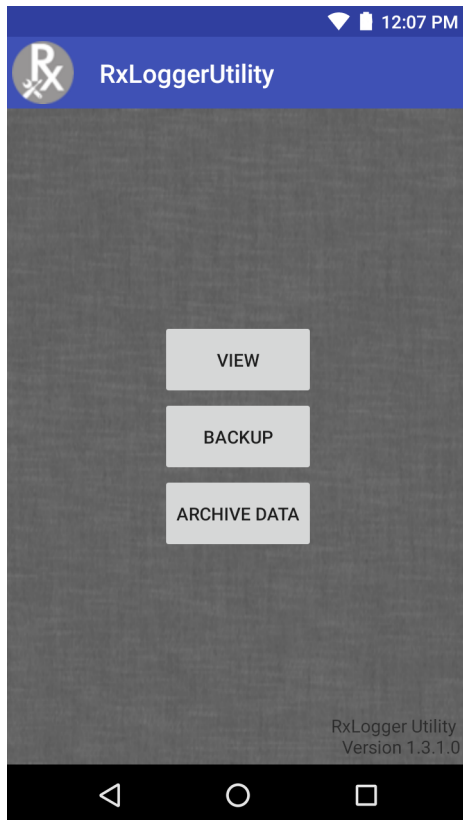
## RxLogger Utility

RxLogger Utility is a data monitoring application for viewing logs in the MC33XX while RxLogger is running. The user can access the logs and RxLogger Utility features in the App View or the Overlay View.

### App View

In App View the user views logs in the RxLogger Utility.

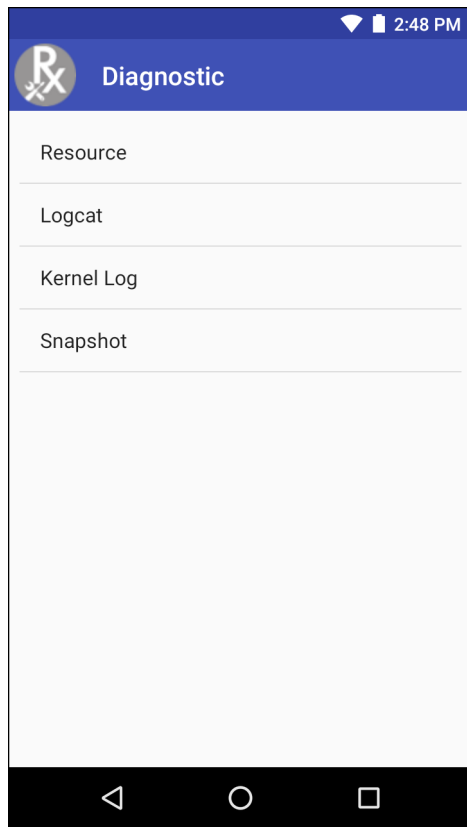
Figure 117 App View



### Viewing Logs

Touch **View**. The **Diagnostic** window appears.

Figure 118 Diagnostic Window

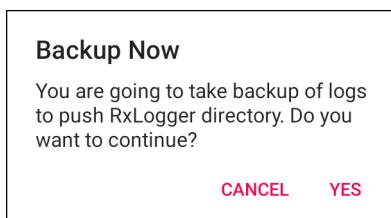


- **Resource** - View all resources.
- **Logcat** - View all the Logcat files. Messages are colored according to flags. Verbose messages is orange text, Assert messages are in brown text, Fail messages are in purple text, Warning messages are in yellow text, information messages are in blue text, debug messages are in green text, and error messages are in red.
- **Kernel Log** - View all the Kernel Logs.
- **Snapshot** - View all the Snapshot.

## Backup

RxLogger Utility allows the user to make a zip file of the **RxLogger** folder in the device, which by default contains all the RxLogger logs stored in the device.

Figure 119 Backup Message

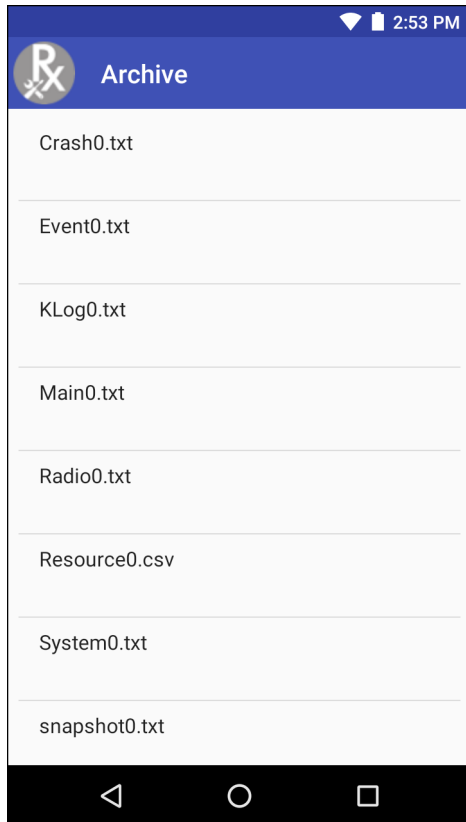


Touch **Yes** to save the backup data.

## Archiving

The user can view all the RxLogger logs stored in the RxLogger directory by default. These is not for live-viewing logs.


**Figure 120** Archive



Touch any of the options to view the log files.

## Overlay View

To initiate Overlay view:

1. Open **RxLogger**.
2. Touch  > **Toggle Chat Head**. The Main Chat Head icon appears on the screen.  
The user can drag the Main Chat head icon around the screen. Touch the icon to open the Overlay View.

## Removing the Main Chat Head

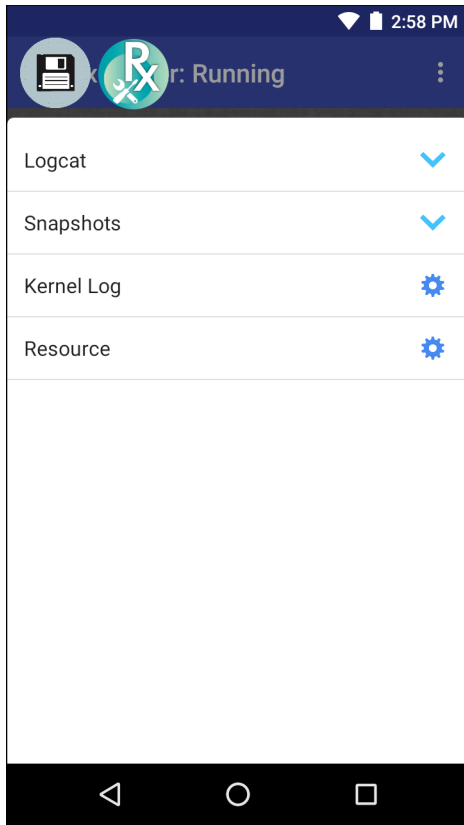
To remove the Main Chat Head icon:

1. Touch and drag the icon. A circle with an X appears.
2. Move the icon over the circle and then release.

## Viewing Logs

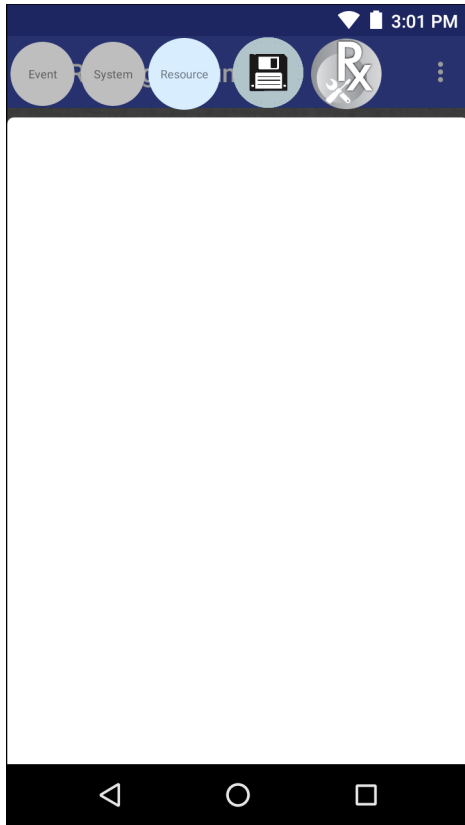
To view logs:

1. Touch the Main Chat head icon. The In View screen appears.

**Figure 121** In View Screen

2. Touch a log to open it. The user can open many logs with each displaying a new sub Chat Head.
3. Touch a sub Chat Head to display the log contents. If there are more sub Chat Head icon, scroll left or right to view additional icons.

Figure 122 Log File



### Removing a Sub Chat Head Icon

To remove a sub chat Head icon, press and hold the icon until it disappears.

### Backup

RxLogger Utility allows the user to make a zip file of the RxLogger folder in the device, which by default contains all the RxLogger logs stored in the device.

Backup Now icon is always available in the Overlay View.

1. Touch the Backup Now icon. The Backup dialog box appears.
2. Touch **Yes** to create the back up.

---

## About Phone

Use About phone settings to view information about the MC33XX. Swipe down with two fingers from the status bar to open the quick access panel and then touch  >  **About phone**.

- **Status** - Touch to display the following:
    - **Battery status** - Indicates if the battery is charging (on AC power) or discharging (on battery power).
    - **Battery level** - Indicates the battery charge level.
    - **IP address** - Displays the IP address of the device.
    - **Wi-Fi MAC address** - Displays the Wi-Fi radio MAC address.
    - **Ethernet MAC address** - Displays the Ethernet driver MAC address.
    - **Bluetooth address** - Displays the Bluetooth radio Bluetooth address.
    - **Serial number** - Displays the serial number of the device.
    - **Up time** - Displays the time that the MC33XX has been running since being turned on.
  - **Battery Information** - Displays information about the battery.
  - **SW components** - Lists filenames and versions for various software on the MC33XX.
  - **Legal information** - Opens a screen to view legal information about the software included on the MC33XX.
  - **Model** - Displays the devices model number.
  - **Android version** - Displays the operating system version.
  - **Android security patch level** - Displays the security patch level date.
  - **Kernel version** - Displays the kernel version.
  - **Build fingerprint** - Defines Device Manufacturer, Model, Android version and Build version together in one location.
  - **Device update version** - Displays the patch version if any updates are installed on top of the base build.
  - **Build Number** - Displays the software build number.
-



# Application Deployment

---

## Introduction

This chapter describes features in Android including new security features, how to package applications, and procedures for deploying applications onto the device.

---

## Security

The device implements a set of security policies that determine whether an application is allowed to run and, if allowed, with what level of trust. To develop an application, you must know the security configuration of the device, and how to sign an application with the appropriate certificate to allow the application to run (and to run with the needed level of trust).



**NOTE:** Ensure the date is set correctly before installing certificates or when accessing secure web sites.

---

## Secure Certificates

If the VPN or Wi-Fi networks rely on secure certificates, obtain the certificates and store them in the device's secure credential storage, before configuring access to the VPN or Wi-Fi networks.



If downloading the certificates from a web site, set a password for the credential storage. The device supports X.509 certificates saved in PKCS#12 key store files with a .p12 extension (if key store has a .pfx or other extension, change to .p12).

The device also installs any accompanying private key or certificate authority certificates contained in the key store.

---

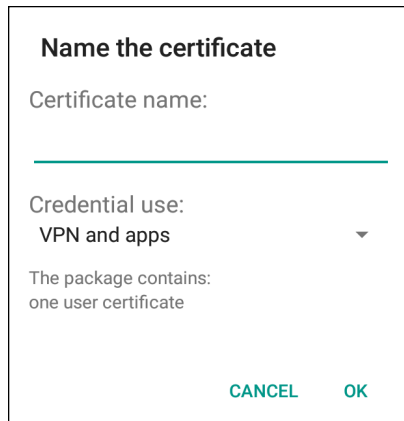
## Installing a Secure Certificate

To install a secure certificate:

1. Copy the certificate from the host computer to the root of the microSD card or the device's internal memory. See [USB Communication](#) for information about connecting the device to a host computer and copying files.
2. Swipe down with two fingers from the status bar to open the quick access panel and then touch .
3. Touch  **Security**.

4. Touch **Install from storage**.
5. Navigate to the location of the certificate file.
6. Touch the filename of the certificate to install.
7. If prompted, enter the password for credential storage. If a password has not been set for the credential storage, enter a password for it twice and then touch **OK**.
8. If prompted, enter the certificate's password and touch **OK**.
9. Enter a name for the certificate and in the Credential use drop-down, select **VPN and apps** or **Wi-Fi**.

**Figure 123** Name the Certificate Dialog Box



**Name the certificate**

Certificate name:

Credential use:  
VPN and apps



The package contains:  
one user certificate

CANCEL OK

10. Touch **OK**.

The certificate can now be used when connecting to a secure network. For security, the certificate is deleted from the microSD card.

## Configuring Credential Storage Settings

1. Swipe down with two fingers from the status bar to open the quick access panel and then touch .
2. Touch  **Security**.
  - **Trusted credentials** - Touch to display the trusted system and user credentials.
  - **Install from storage** - Touch to install a secure certificate from the microSD card.
  - **Clear credentials** - Deletes all secure certificates and related credentials.

---

## License Manager

License Manager is an Android application and is offered to customers having Back-Office Server, Relay/Proxy Server and Local/On-Premise Server infrastructures for manual license activation of Zebra Technologies software products. This then enables the corresponding software or device functionality. The application also shows the list of active licenses on the device along with the products and their features and versions. All the license rights displayed in the application are available for acquisition on the device.

Use License Manager to manage software licenses on the MC33XX. The License Manager administers the software licenses on a device, allowing an administrator or application on the device to control the usability of software features that require licensing. Software components can be made usable, unusable or feature-limited based on the license on the device. If a component requires licensing, the absence of a valid license will limit or prevent its functionality.

## Android Versions Supported


- KitKat
- Lollipop
- Marshmallow
- Nougat

## Requirements

- License Manager and LicenseMgrService applications pre-installed on the device.
- Network Connection
- Back-Office Server, Relay/Proxy Server or Local/On-Premise Server infrastructure setup

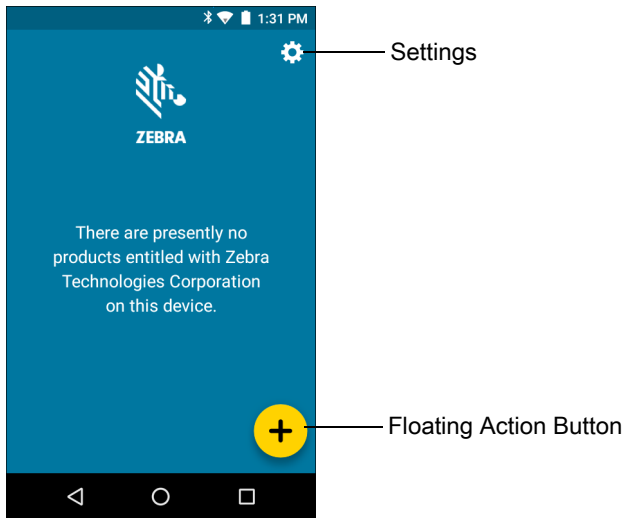
## Start Application

To start License Manager:

1. On the Home screen, swipe up from the bottom of the screen.
2. Touch  **License Manager**.

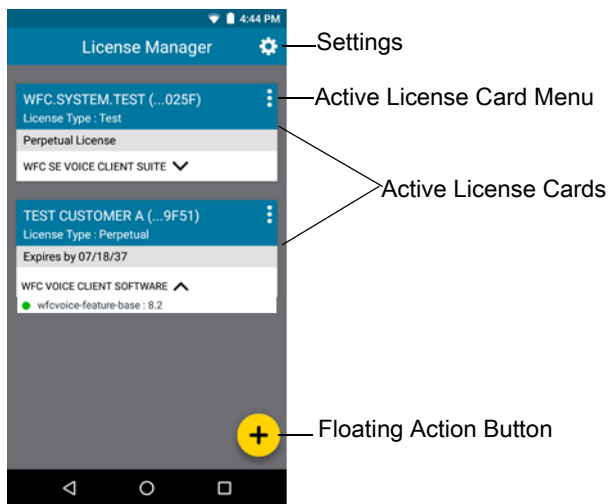
The application starts and displays the following License Manager Home screen, when there are no licenses currently active on the device.

**Figure 124** License Manager Home Screen - Without Licenses



The application starts and displays the following License Manager Home screen, when there are licenses currently active on the device.

**Figure 125** License Manager Home Screen - With Licenses



## Active License Display

All licenses currently active on the device display in the form of cards on the License Manager Home screen. Each card corresponds to an active license. Each license on the License Manager Home screen contains the following information:

**First Row** - Includes the name of the organization who purchased the license along with the last four digits of the activation ID used for activating the license.

**Second Row** - Includes the license type. Valid license types:


- **Perpetual**
- **Permanent**
- **Trial License**
- **Test**

**Third Row** - Includes the expiration date of the license in the format MM/DD/YY. If the license type is Perpetual/Permanent, **Expires Never** displays.

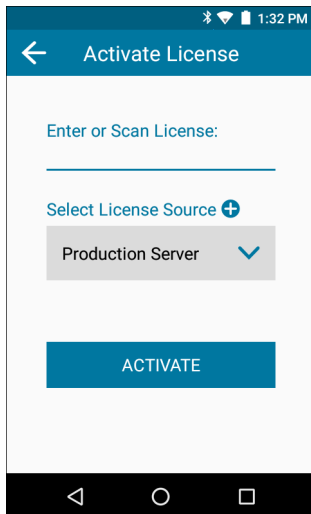
**Remaining Rows** - The rows below the expiration date include a list of products followed by an arrow at the end of each row which enables you to expand each product to view the list of features activated for the product. Each row under a product includes a list of features and their version numbers, which can be used for acquisition on the device.

## Activate License

To activate a license for any Zebra Technologies software products:

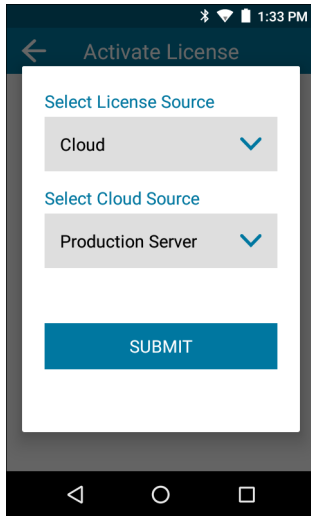
1. On the **MC33XX Home** screen, swipe up from the bottom of the screen.
2. Touch  **License Manager**.  
The **License Manager Home** screen displays.
3. On the **License Manager Home** screen, touch the **Floating Action** button.  
The **Activate License** screen displays.

**Figure 126** Activate License Screen



4. Enter or scan a license.  
Either manually enter a valid activation ID or scan a valid license.
5. Touch **Select License Source**. Choose an existing default license source (Back-Office Servers) or add a new Custom (Proxy/Relay Server) and Local (On-Premise Server) license source.  
The **Source** selection screen displays.

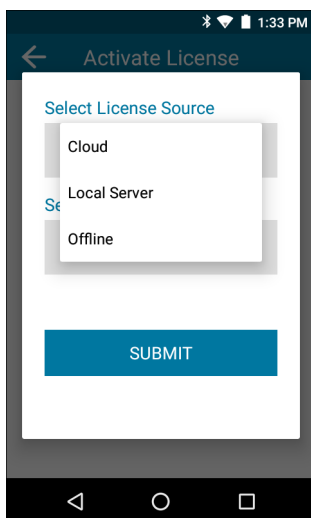
**Figure 127** Source Selection Screen



6. Select **License Source**. This drop-down list includes all the license sources available on the device. A valid license source must be selected. This field usually indicates the name of the server for any of the user-added license sources. There are three default license sources available.
  - **Cloud**
  - **Local Server**
  - **Offline**

The user has the ability to add a new Custom Server or a new Local Server. See [Add License Source on page 183](#). All license sources (Custom/Local) added by the user are read only. All the license sources added by the user are displayed below the three default options.

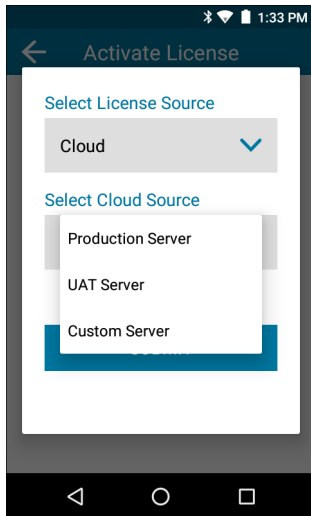
**Figure 128** Select License Source Options



7. Select **Cloud Source**. This drop-down list includes the default servers (Production or UAT) and custom servers (Relay/Proxy Server). This field displays only when the **Select License Source** field is set to **Cloud**. A valid cloud source must be selected. When selecting **Custom Server**, the user is prompted to add a new license source. The license source added corresponds to a custom relay/proxy server set up by the customer.
  - **Production Server**
  - **UAT Server**

- **Custom Server**

**Figure 129** Select Cloud Source Options



8. Enter the **URL** of the license source. This field only displays when the user is given the option to add a new license source for **Custom Server** and **Local Server**. This field is visible while viewing any user-added license source which will be read-only.
9. Enter **Name**. This field only displays when the user is given the option to add a new license source for **Custom Server** and **Local Server**. A valid unique name of the license source must be entered. This field is visible while viewing any user-added license source. The name added in this field is added to the list of license sources saved on the device.
10. Touch **Submit**.

The application validates the information and connects to the selected License Source, and displays whether the license activation was successful or not.

If the license activation is successful, the activated license information displays in the form of a card on the **License Manager Home** screen.

All of the license rights displayed on the **License Manager Home** screen are available for acquisition on the device.

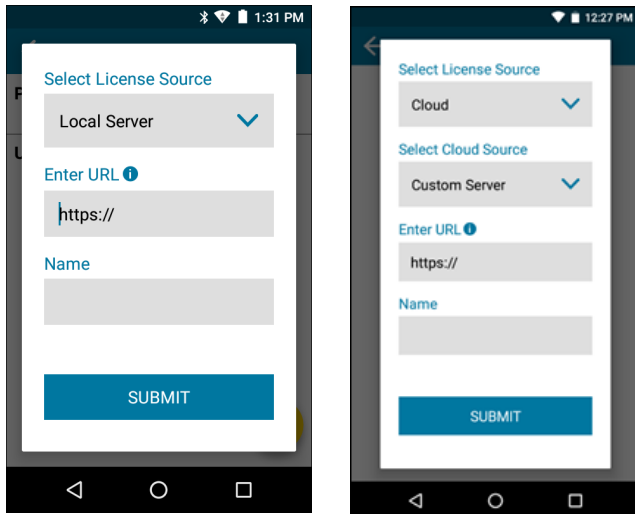
## Add License Source

The user has the option to add a new Custom Server or a Local Server license source. New license sources can be added from the **Activate License** screen or from the **License Source Settings** screen.

To add a new license source from the **Activate License** screen:

1. Add a **License Source** (Local or Custom):
  - Local:** From the **Select License Source** drop-down list, select **Local Server** to add a local license source.
  - Custom:** From the **Select License Source** drop-down list, select **Cloud** and from the **Select Cloud Source** drop-down list, select **Custom Server**.

**Figure 130** Select License Source Screen



2. Enter a valid server URL and a unique name to identify the license source.
3. Touch **Submit**.


All the valid license sources added by the user (Custom/Local) are available for selection in the **Select License Source** list in the **License Source** screen while activating a license. All the license sources also display in the **License Sources Settings** screen.




**NOTE:** All license sources (Custom and Local) added by the user are read only. A maximum of ten license sources can be saved on the device at a time, including the default Production and UAT license sources. Therefore, the user can add a maximum of eight license sources (Custom license source only, Local license source only, or a combination of both).

## Refresh a License

To refresh a license which is currently active on the device:

1. On the **MC33XX Home** screen, swipe up from the bottom of the screen.
2. Touch  **License Manager**.  
The **License Manager Home** screen displays.
3. Activate a license if no licenses are currently active on the device. For more information, see [Activate License on page 181](#).

Once one or more licenses are currently active on the device, the user can see the **License Manager Home** screen with a list of cards.

4. Choose the license that needs to be refreshed and touch .
5. Touch **Refresh License**.



A request is sent to the server to refresh the selected license. Once the license is successfully refreshed, all the information in the card corresponding to the license is updated.

## Settings

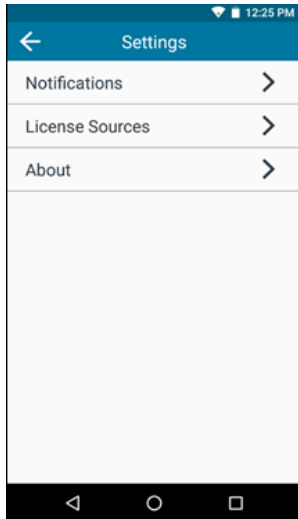
To access License Manager Settings:

1. On the **MC33XX Home** screen, swipe up from the bottom of the screen.



2. Touch  **License Manager**.  
The **License Manager Home** screen displays.
3. Touch  **Settings**.

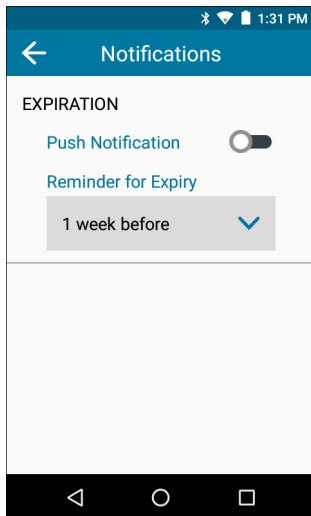
**Figure 131** Settings Screen



## Notifications Settings

Use Notifications to set whether you want to receive push notifications and a reminder for the license expirations.

**Figure 132** Notifications



**Push Notification** - Toggle the switch to the ON position, to receive notifications on the device for license expiry.

**Reminder for Expiry** - Touch the drop-down list, to set the time period before which the user is notified of license expiry.

- **1 week before** (default)
- **2 weeks before**
- **3 weeks before**

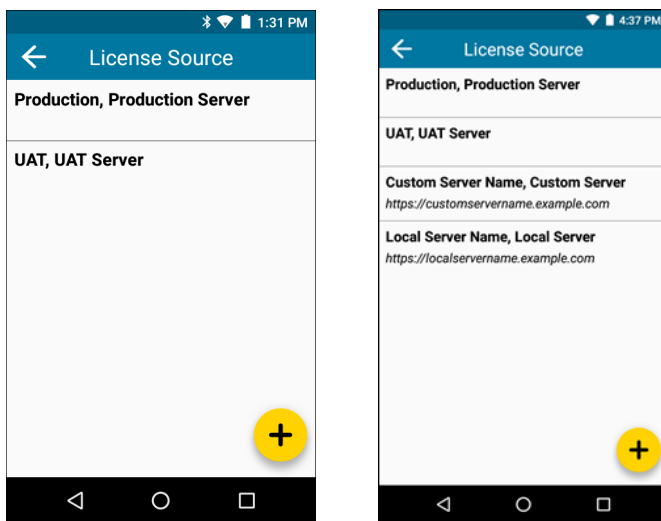
- **4 weeks before**

Once the **Push Notification** switch is set and the desired time period is chosen, a notification appears in the Status Bar if any licenses currently active on the device is going to expire within the time period set. The user is notified of the license expiry within the time frame and the product name and activation ID displays in the notification. The user can click on the notification from the Notifications pull-down which redirects the user to the **License Manager Home** screen.

## License Sources Settings

All the license sources available on the device can be viewed by selecting the **License Sources** option on the Settings screen. This screen can also be opened by selecting License Source from the menu on the License Manager Home screen.

**Figure 133** License Source Screen



The first two items in the License Source screen are the default license sources:



- **Production Server**
- **UAT Server**

These two license sources are followed by user-added license sources.

### Add License Source in Settings

The user can add a new Custom Server or a Local Server license source. New license sources can be added from the **Activate License** screen or from the **License Source Settings** screen.

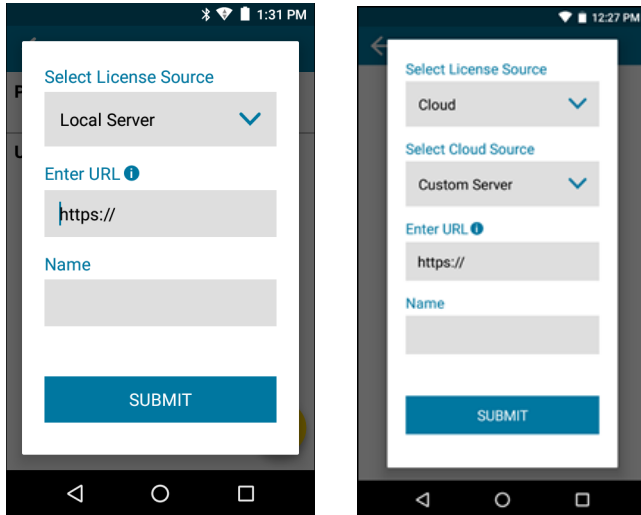
To add a new license source from the **License Source Settings** screen:

1. On the **MC33XX Home** screen, swipe up from the bottom of the screen.
2. Touch  **License Manager**.  
The **License Manager Home** screen displays.
3. Touch  **Settings**.
4. Touch **License Sources**.
5. Touch the **Floating Action** button (plus icon) on the bottom right corner of the **License Source** screen.
6. Add a **License Source** (Local or Custom):

**Local:** From the **Select License Source** drop-down list, select **Local Server** to add a local license source.

**Custom:** From the **Select License Source** drop-down list, select **Custom Server** to add a custom license source.

**Figure 134** Select License Source Screen



7. Enter a valid server URL and a unique name to identify the license source.
8. Touch **Submit**.

The recently added license source on the **Settings** screen is automatically selected as the current license source in the **Activate License** screen. All the valid license sources added by the user (Custom/Local) are available for selection in the **Select License Source** list in the **License Source** screen while activating a license.

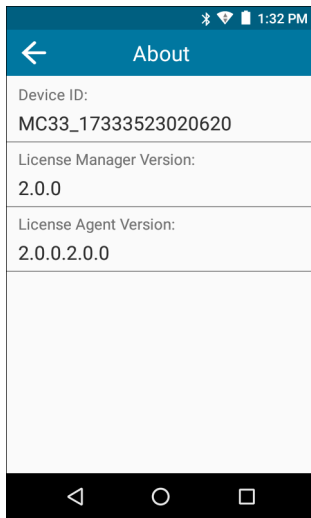


**NOTE:** All license sources (Custom and Local) added by the user are read only. A maximum of ten license sources can be saved on the device at a time, including the default Production and UAT license sources. Therefore, the user can add a maximum of eight license sources (Custom license source only, Local license source only, or a combination of both).

## About Settings

The information that displays on the About screen is read only and depends on the device and the version of the License Manager application installed on the device.

**Figure 135** About Screen



**Device ID** - Displays the unique serial number of the device on which License Manager is installed.

**License Manager Version** - Displays the version of License Manager installed on the device.

**License Agent Version** - Displays the version of the License Agent installed on the device.

## Development Tools

### Android

Android development tools are available at [developer.android.com](http://developer.android.com).


To start developing applications for the device, download the development SDK and the Eclipse IDE. Development can take place on a Microsoft® Windows®, Mac® OS X®, or Linux® operating system.


Applications are written in the Java language, but compiled and executed in the Dalvik VM (a non-Java virtual machine). Once the Java code is compiled cleanly, the developer tools make sure the application is packaged properly, including the AndroidManifest.xml file.

The development SDK is distributed as a ZIP file that unpacks to a directory on the host computer hard drive. The SDK includes:

- android.jar
  - Java archive file containing all of the development SDK classes necessary to build an application.
- documentation.html and docs directory
  - The SDK documentation is provided locally and on the Web. It's largely in the form of JavaDocs, making it easy to navigate the many packages in the SDK. The documentation also includes a high-level Development Guide and links to the broader community.
- Samples directory
  - The samples subdirectory contains full source code for a variety of applications, including ApiDemo, which exercises many APIs. The sample application is a great place to explore when starting application development.
- Tools directory
  - Contains all of the command-line tools to build applications. The most commonly employed and useful tool is the adb utility.
- usb\_driver
  - Directory containing the necessary drivers to connect the development environment to an enabled device. These files are only required for developers using the Windows platform.

Open the **Developer options** screen to set development related settings.

By default, the Developer Options are hidden. To un-hide the developer options, swipe down with two fingers from the status bar to open the quick access panel and then touch .

Touch . **About device**. Scroll down to **Build number**. Tap **Build number** seven times until **You are now a developer** appears.

Touch  >  **Developer options**. Slide the switch to the **ON** position to enable developer options.

## EMDK for Android

EMDK for Android provides developers with a comprehensive set of tools to easily create powerful line-of-business applications for enterprise mobile computing devices. It's designed for Google's Android SDK and Android Studio, and includes class libraries, sample applications with source code, and all associated documentation to help your applications take full advantage of what Zebra devices have to offer.

The kit also delivers Profile Manager, a GUI-based device configuration tool providing exclusive access to the Zebra MX device management framework. This allows developers to configure Zebra devices from within their applications in less time, with fewer lines of code and with fewer errors.

For more information go to: [techdocs.zebra.com](http://techdocs.zebra.com).

## StageNow

StageNow is Zebra's next-generation Android Staging Solution, supporting Android Lollipop, KitKat®, and Jelly Bean operating systems, and built on the MX 4.3/4.4/5.x/6.0 platform. It allows quick and easy creation of device profiles, and can deploy to devices simply by scanning a bar code, reading a tag, or playing an audio file.

The StageNow Staging Solution includes the following components:

- The StageNow Workstation tool installs on the staging workstation (host computer) and lets the administrator easily create staging profiles for configuring device components, and perform other staging actions such as checking the condition of a target device to determine suitability for software upgrades or other activities. The StageNow Workstation stores profiles and other created content for later use.
- The StageNow Client resides on the device and provides a user interface for the staging operator to initiate staging. The operator uses one or more of the desired staging methods (print and scan a bar code, read an NFC tag or play an audio file) to deliver staging material to the device.

For more information go to: [techdocs.zebra.com](http://techdocs.zebra.com).

---





## ADB USB Setup

To use the ADB, install the USB driver. This assumes that the development SDK has been installed on the host computer. Go to [developer.android.com/sdk/index.html](http://developer.android.com/sdk/index.html) for details on setting up the development SDK.

ADB driver for Windows and Linux are available on the Zebra Support Central web site at [www.zebra.com/support](http://www.zebra.com/support). Download the ADB and USB Driver Setup package. Following the instructions with the package to install the ADB and USB drivers for Windows and Linux.

## Enabling USB Debugging

By default, USB debugging is disabled. To enable USB debugging:

1. Swipe down with two fingers from the status bar to open the quick access panel and then touch .
2. Touch  **About phone**.
3. Scroll down to **Build number**.
4. Tap **Build number** seven time. The message **You are now a developer!** appears.
5. Touch .
6. Touch  **Developer options**.
7. Slide the **USB debugging** switch to the **ON** position.

8. Touch **OK**.
9. Connect the device to the host computer using the Rugged Charge/USB Cable.  
The **Allow USB debugging?** dialog box appears on the device.
10. On the device, touch **OK**.
11. On the host computer, navigate to the `platform-tools` folder.
12. Type `adb devices`.  
The following displays:  
`List of devices attached`  
`XXXXXXXXXXXXXXXX device (where XXXXXXXXXXXXXXXXXXXX is the device number).`



**NOTE:** If device number does not appear, ensure that ADB drivers are installed properly.

13. Touch **O**.

---

## Application Installation

After an application is developed, install the application onto the device using one of the following methods:

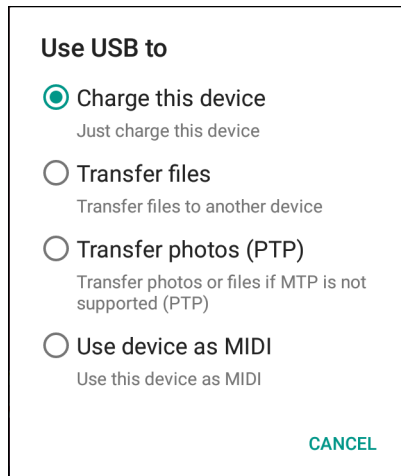
- USB connection, see [Installing Applications Using the USB Connection on page 191](#).
- Android Debug Bridge, see [Installing Applications Using the Android Debug Bridge on page 193](#).
- microSD Card, see [Installing Applications Using a microSD Card on page 194](#)
- Mobile device management (MDM) platforms that have application provisioning. Refer to the MDM software documentation for details.

## Installing Applications Using the USB Connection



**CAUTION:** When connecting the device to a host computer and mounting its microSD card, follow the host computer's instructions for connecting and disconnecting USB devices, to avoid damaging or corrupting files.





1. Connect the device to a host computer using the Rugged Charge/USB cable.
2. Pull down the Notification panel and touch **USB for Charging**.

**Figure 136** Use USB Dialog Box

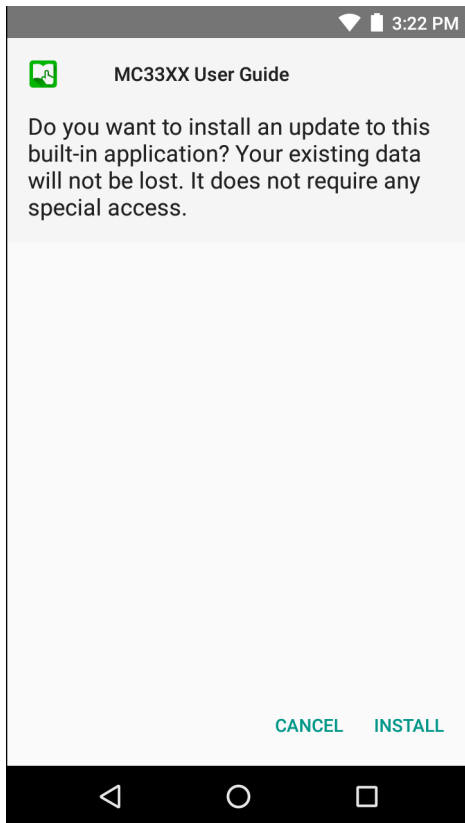
3. Touch **Transfer files**.
4. On the host computer, open a file explorer application.
5. On the host computer, copy the application .apk file from the host computer to the device.



**CAUTION:** Carefully follow the host computer's instructions to unmount the microSD card and disconnect USB devices correctly to avoid losing information.

6. Disconnect the device from the host computer.
7. Swipe down with two fingers from the status bar to open the quick access panel and then touch .
8. Touch  **Security**.
9. Slide the **Unknown sources** switch to the **ON** position.
10. Touch **OK**.
11. Touch .
12. Swipe the screen up and select  to view files on the microSD card or Internal Storage.
13. Locate the application .apk file.
14. Touch the application file to begin the installation process.



**Figure 137** Accept Installation Screen

15. To confirm installation and accept what the application affects, touch **Install** otherwise touch **Cancel**.
16. Touch **Open** to open the application or **Close** to exit the installation process. The application appears in the App list.


## Installing Applications Using the Android Debug Bridge

Use ADB commands to install application onto the device.



**CAUTION:** When connecting the device to a host computer and mounting its microSD card, follow the host computer's instructions for connecting and disconnecting USB devices, to avoid damaging or corrupting files.

Ensure that the ADB drivers are installed on the host computer. See [ADB USB Setup on page 190](#).

1. Connect the device to a host computer using USB. See [USB Communication](#).
2. Swipe down with two fingers from the status bar to open the quick access panel and then touch .
3. Touch **{ } Developer options**.
4. Slide the switch to the **ON** position.
5. Touch **USB Debugging**. A check appears in the check box. The **Allow USB debugging?** dialog box appears.
6. Touch **OK**.
7. On the host computer, open a command prompt window and use the adb command:
 

```
adb install <application>
```






 where: <application> = the path and filename of the apk file.

8. Disconnect the device from the host computer. See [USB Communication](#).

## Installing Applications Using a microSD Card





**CAUTION:** When connecting the device to a host computer and mounting its microSD card, follow the host computer's instructions for connecting and disconnecting USB devices, to avoid damaging or corrupting files.

1. Connect the device to a host computer using USB. See [USB Communication](#).
  2. Copy the application APK file from the host computer to the microSD card.
  3. Remove the microSD card from the host computer.
  4. Press and hold the Power button until the menu appears.
  5. Touch **Power off**.
  6. Press the two battery latches in.
  7. Lift the battery from the device.
  8. Lift the access door.
  9. Insert the microSD card.
  10. Replace the access door.
  11. Insert the battery, bottom first, into the battery compartment in the back of the device.
  12. Press the battery down until the battery release latches snap into place.
  13. Press and hold the Power button to turn on the device.
  14. Swipe down with two fingers from the status bar to open the quick access panel and then touch .
  15. Touch  **Security**.
  16. Slide the **Unknown sources** switch to the **ON** position.
  17. Touch **OK**.
  18. Touch .
  19. Swipe down with two fingers from the status bar to open the quick access panel and then touch .
- ✓ **NOTE:** In **File Browser**, the microSD card path is `/storage/sdcard1`.
20. Touch  to view files on the microSD card.
  21. Locate the application APK file.
  22. Touch the application file to begin the installation process.
  23. To confirm installation and accept what the application affects, touch **Install** otherwise touch **Cancel**.
  24. Touch **Open** to open the application or **Close** to exit the installation process. The application appears in the App list.

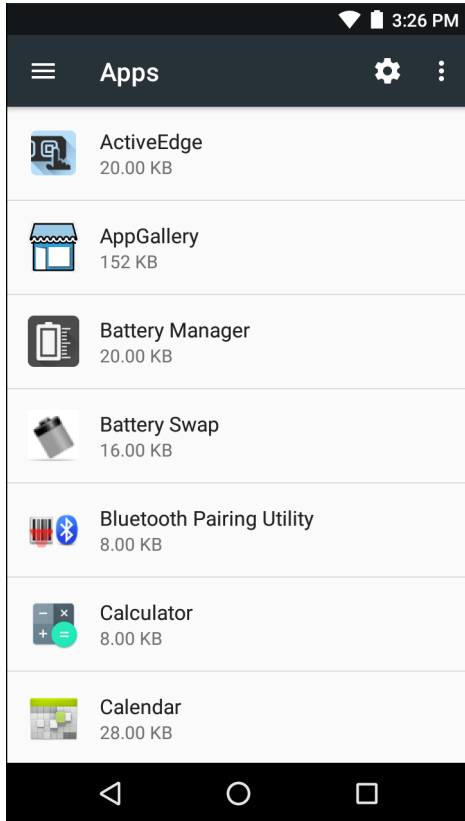
## Uninstalling an Application

To uninstall an application:

1. Swipe down with two fingers from the status bar to open the quick access panel and then touch .
2. Touch  **Apps**.

3. Scroll through the list to the application.

**Figure 138** Downloaded Screen



4. Touch the application to uninstall.
5. Touch **Uninstall**.
6. Touch **OK** to confirm.

---

## Performing a System Update

System Update packages can contain either partial or complete updates for the operating system. Zebra distributes the System Update packages on the Zebra Support & Downloads web site. Perform system update using either a microSD card or using ADB.

### Download the System Update Package

Download the system update package:

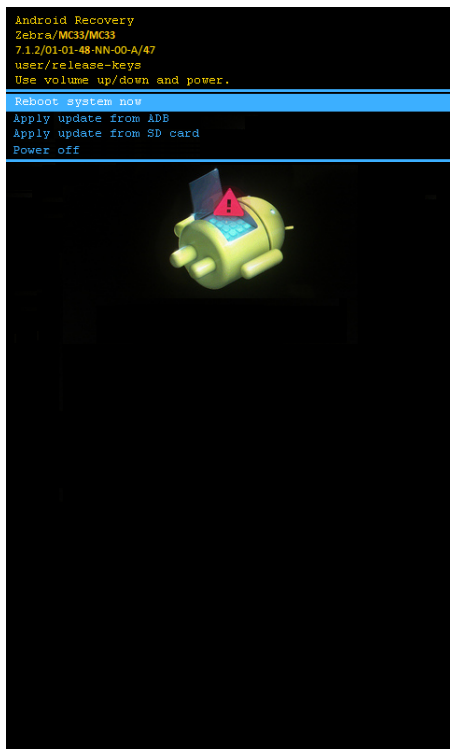
1. Go to the Zebra Support & Downloads web site, [www.zebra.com/support](http://www.zebra.com/support).
2. Download the appropriate System Update package to a host computer.

### Using microSD Card

1. Copy the System Update zip file to the root of the microSD card.

- Copy the zip file to a microSD card using a host computer (see [USB Communication](#) for more information) and then installing the microSD card into the device (see [Installing a microSD Card on page 19](#) for more information).
  - Connect the device with a microSD card already installed to the host computer and copy zip file to the microSD card. See [USB Communication](#) for more information. Disconnect the device from the host computer.
2. Press and hold the Power button until the menu appears.
  3. Touch **Reboot**.
  4. Touch **OK**. The device resets.
  5. On the MC33XX-G, press and hold the trigger until the Zebra Technologies logo appears, and then release the trigger. The System Recovery screen appears.  
On the MC33XX-R/S, press and hold the right or left yellow side key scan button until the Zebra Technologies logo appears, and then release the side key scan button. The System Recovery screen appears.

**Figure 139** System Recovery Screen





6. Press the Volume Up and Volume Down buttons to navigate to **apply from sdcard**.
7. Press the Power button.
8. Use the Volume Up and Volume Down buttons to navigate to the System Update file.
9. Press the Power button. The System Update installs and then the device returns to the Recovery screen.
10. Press the Power button to reboot the device.



**NOTE:** If installing GMS software on a device that had Non-GMS software or Non-GMS software on a device that had GMS software, perform a Factory or Enterprise reset (retains enterprise data).

## Using ADB

To update the system using ADB:

1. Connect the device to the Rugged Charge/USB cable or insert the device into the 1-Slot USB/Charge Only Cradle.
2. Connect the cable or cradle to the host computer.
3. On the device, swipe down with two fingers from the status bar to open the quick access panel and then touch .
4. Touch  **Developer options**.
5. Slide the switch to the **ON** position.
6. Touch **USB Debugging**. A check appears in the check box. The **Allow USB debugging?** dialog box appears.
7. Touch **OK**.
8. On the host computer, open a command prompt window and use the adb command:  
`adb devices`  
 The following displays:  
**List of devices attached**  
 XXXXXXXXXXXXXXXX device (where XXXXXXXXXXXXXXXX is the device number).



✓ **NOTE:** If device number does not appear, ensure that ADB drivers are installed properly.

9. Type:  
`adb reboot recovery`
10. Press Enter. The System Recovery screen appears. See [Figure 139 on page 196](#).
11. Press the Volume Up and Volume Down buttons to navigate to **apply from adb**.
12. Press the Power button.
13. On the host computer command prompt window type:  
`adb sideload <file>`  
 where: <file> = the path and filename of the zip file.
14. Press Enter. The System Update installs (progress appears as percentage in the Command Prompt window) and then the Recovery screen appears.
15. Press the Power button to reboot the device.

✓ **NOTE:** If installing GMS software on a device that had Non-GMS software or Non-GMS software on a device that had GMS software, perform a Factory or Enterprise reset (retains enterprise data).

## Verify System Update Installation

To check that the system update installed properly:

1. On the device, swipe down with two fingers from the status bar to open the quick access panel and then touch .
2. Touch  **About phone**.
3. Scroll down to **Build number**.
4. Ensure that the build number matches the new system update package file number.

---

## Performing an Enterprise Reset

An Enterprise Reset erases all data in the `/cache` and `/data` partitions and clears all device settings, except those in the `/enterprise` partition.

Before performing an Enterprise Reset, copy all applications and the key remap configuration file that you want to persist after the reset into the `/enterprise/usr/persist` folder.

Perform Enterprise Reset using either a microSD card or using ADB.

### Download the Enterprise Reset Package

Download the system update package:


1. Go to the Zebra Support & Downloads web site, [www.zebra.com/support](http://www.zebra.com/support).
2. Download the Enterprise Reset file to a host computer.

### Using microSD Card

1. Copy the Enterprise Reset zip file to the root of the microSD card.
  - Copy the zip file to a microSD card using a host computer (see [USB Communication](#) for more information) and then installing the microSD card into the device (see [Installing a microSD Card on page 19](#) for more information).
  - Connect the device with a microSD card already installed to the host computer and copy zip file to the microSD card. See [USB Communication](#) for more information. Disconnect the device from the host computer.
2. Press and hold the Power button until the menu appears.
3. Touch **Reboot**.
4. Touch **OK**. The device resets.
5. On the MC33XX-G, press and hold the trigger until the Zebra Technologies logo appears, and then release the trigger. The System Recovery screen appears. See [Figure 139 on page 196](#).  
On the MC33XX-R/S, press and hold the right or left yellow side key scan button until the Zebra Technologies logo appears, and then release the side key scan button. The System Recovery screen appears. See [Figure 139 on page 196](#).
6. Press the Up and Down Volume buttons to navigate to the **apply update from sdcard**.
7. Press the Power button.
8. Press the Up and Down Volume buttons to navigate to the Enterprise Reset file.
9. Press the Power button. The Enterprise Reset occurs and then the device returns to the Recovery screen.
10. Press the Power button.

### Using ADB

To perform an Enterprise Reset using ADB:

1. Connect the device to the Rugged Charge/USB cable or insert the device into the 1-Slot USB/Charge Only Cradle.
2. Connect the cable or cradle to the host computer.
3. On the device, swipe down with two fingers from the status bar to open the quick access panel and then touch .

4. Touch **{ }** **Developer options**.
5. Slide the switch to the **ON** position.
6. Touch **USB Debugging**. A check appears in the check box. The **Allow USB debugging?** dialog box appears.
7. Touch **OK**.
8. On the host computer, open a command prompt window and type:  
`adb devices`.  
The following displays:  
`List of devices attached`  
`XXXXXXXXXXXXXXXXX device (where XXXXXXXXXXXXXXXXXXXX is the device number).`

✓ **NOTE:** If device number does not appear, ensure that ADB drivers are installed properly.

9. Type:  
`adb reboot recovery`
10. Press Enter. The System Recovery screen appears. See [Figure 139 on page 196](#).
11. Press the Volume Up and Volume Down buttons to navigate to **apply from adb**.
12. Press the Power button.
13. On the host computer command prompt window type:  
`adb sideload <file>`  
where: <file> = the path and filename of the zip file.
14. Press Enter. The Enterprise Reset package installs and then the Recovery screen appears.
15. Press the Power button to reboot the device.

---

## Performing a Factory Reset

A Factory Reset erases all data in the `/cache`, `/data` and `/enterprise` partitions in internal storage and clears all device settings. A Factory Reset returns the device to the last installed operating system image. To revert to a previous operating system version, re-install that operating system image. See [Performing a System Update on page 195](#) for more information.

### Download the Factory Reset Package

Download the Factory Reset package:

1. Go to the Zebra Support & Downloads web site, [www.zebra.com/support](http://www.zebra.com/support).
2. Download the appropriate Factory Reset file to a host computer.


### Using microSD Card

1. Copy the Factory Reset zip file to the root of the microSD card.
  - Copy the zip file to a microSD card using a host computer (see [USB Communication](#) for more information) and then installing the microSD card into the device (see [Installing a microSD Card on page 19](#) for more information).
  - Connect the device with a microSD card already installed to the host computer and copy zip file to the microSD card. See [USB Communication](#) for more information. Disconnect the device from the host computer.

2. Press and hold the Power button until the menu appears.
3. Touch **Reboot**.
4. Touch **OK**. The device resets.
5. On the MC33XX-G, press and hold the trigger until the Zebra Technologies logo appears, and then release the trigger. The System Recovery screen appears. See [Figure 139 on page 196](#).
6. On the MC33XX-R/S, press and hold the right or left yellow side key scan button until the Zebra Technologies logo appears, and then release the side key scan button. The System Recovery screen appears. See [Figure 139 on page 196](#). See [Figure 139 on page 196](#).
7. Press the Up and Down Volume buttons to navigate to the **apply update from sdcard**.
8. Press the Power button.
9. Press the Up and Down Volume buttons to navigate to the Factory Reset file.
10. Press the Power button. The Factory Reset occurs and then the device returns to the Recovery screen.
11. Press the Power button.

## Using ADB

To perform an Factory Reset using ADB:

1. Connect the device to the Rugged Charge/USB cable or insert the device into the 1-Slot USB/Charge Only Cradle.
2. Connect the cable or cradle to the host computer.
3. On the device, swipe down with two fingers from the status bar to open the quick access panel and then touch .
4. Touch **{ } Developer options**.
5. Slide the switch to the **ON** position.
6. Touch **USB Debugging**. A check appears in the check box. The **Allow USB debugging?** dialog box appears.
7. Touch **OK**.
8. On the host computer, open a command prompt window and use the adb command:  
`adb reboot recovery`
9. Press Enter. The System Recovery screen appears. See [Figure 139 on page 196](#).
10. Press the Volume Up and Volume Down buttons to navigate to **apply from adb**.
11. Press the Power button.
12. On the host computer, open a command prompt window and use the adb command:  
`adb devices`.  
The following displays:  
`List of devices attached`  
`XXXXXXXXXXXXXXXX device (where XXXXXXXXXXXXXXXXXXXX is the device number).`

✓ **NOTE:** If device number does not appear, ensure that ADB drivers are installed properly.

13. Type:  
`adb reboot recovery`
14. Press Enter. The System Recovery screen appears. See [Figure 139 on page 196](#).
15. Press the Volume Up and Volume Down buttons to navigate to **apply from adb**.



16. Press the Power button.
17. On the host computer command prompt window type:  
`adb sideload <file>`  
where: <file> = the path and filename of the zip file.
18. Press Enter. The Factory Reset package installs and then the Recovery screen appears.
19. Press the Power button to reboot the device.

---

## Storage

The device contains four types of file storage:

- Random Access Memory (RAM)
- Internal storage
- External storage (microSD card)
- Enterprise folder.

## Random Access Memory

Executing programs use RAM to store data. Data stored in RAM is lost upon a reset. The operating system manages how applications use RAM. It only allows applications and component processes and services to use RAM when required. It may cache recently used processes in RAM, so they restart more quickly when opened again, but it will erase the cache if it needs the RAM for new activities.



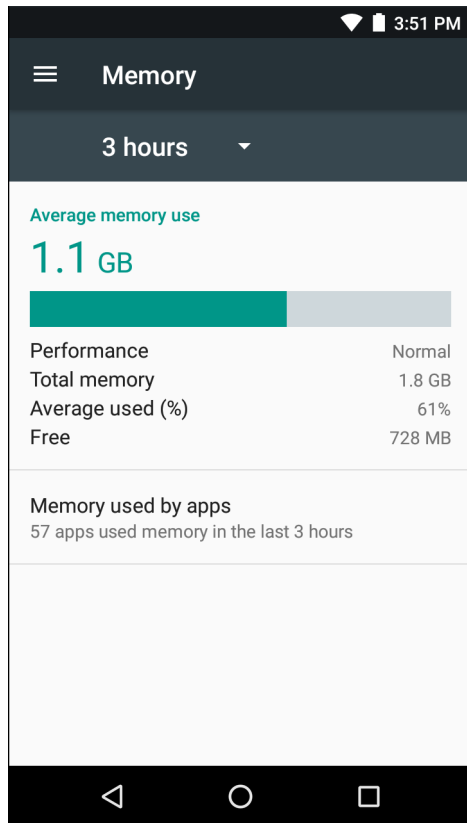
To view the amount of free and used memory, touch  >  **Memory**.

Figure 140 Memory Screen





The screen displays the amount of used and free RAM.

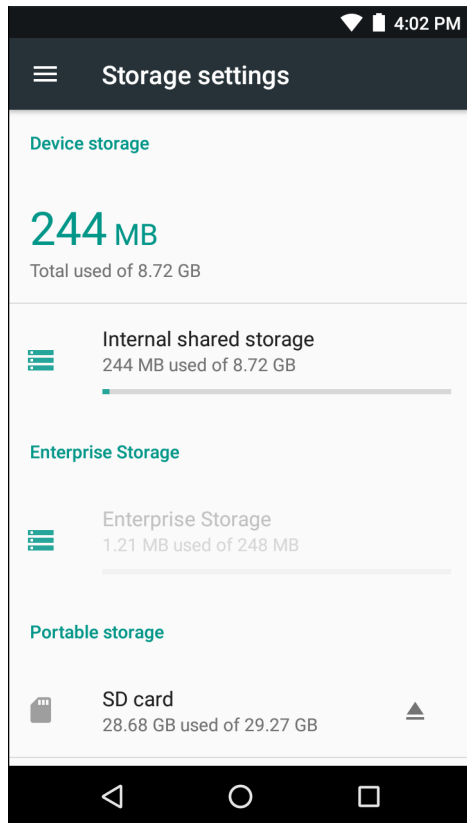
## Internal Storage

The device has internal storage. The internal storage content can be viewed and files copied to and from when the device is connected to a host computer. Some applications are designed to be stored on the internal storage rather than in internal memory.

To view the used and available space on the internal storage:

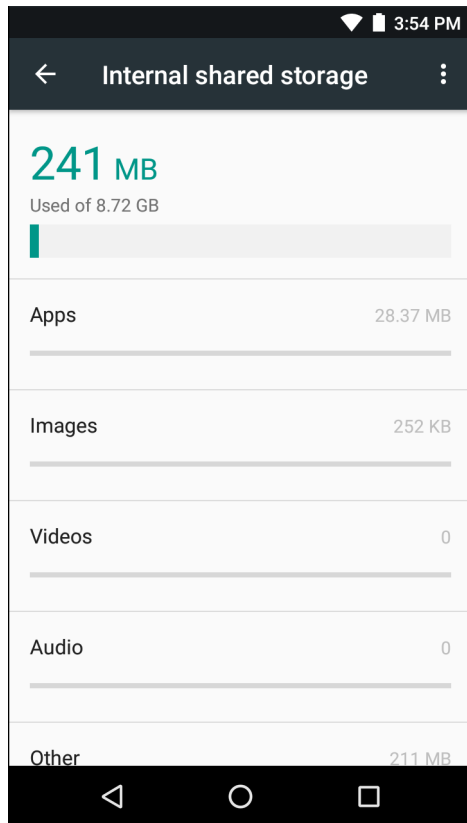
1. Swipe down with two fingers from the status bar to open the quick access panel and then touch .
2. Touch  **Storage**.

**Figure 141** Storage Screen



- **Internal Storage** - Displays the total amount of space on internal storage and amount used.



Touch **Internal shared storage** to display the amount of storage used by apps, photos, videos, audio and other files.

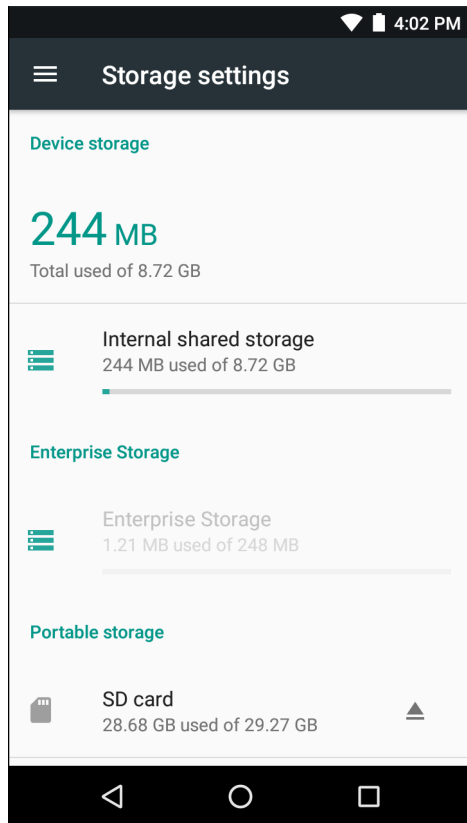
**Figure 142** Internal Storage Screen

## External Storage

The MC33XX can have a removable microSD card. The microSD card content can be viewed and files copied to and from when the MC33XX is connected to a host computer.

To view the used and available space on the microSD card:

1. Swipe down with two fingers from the status bar to open the quick access panel and then touch .
2. Touch  **Storage**.

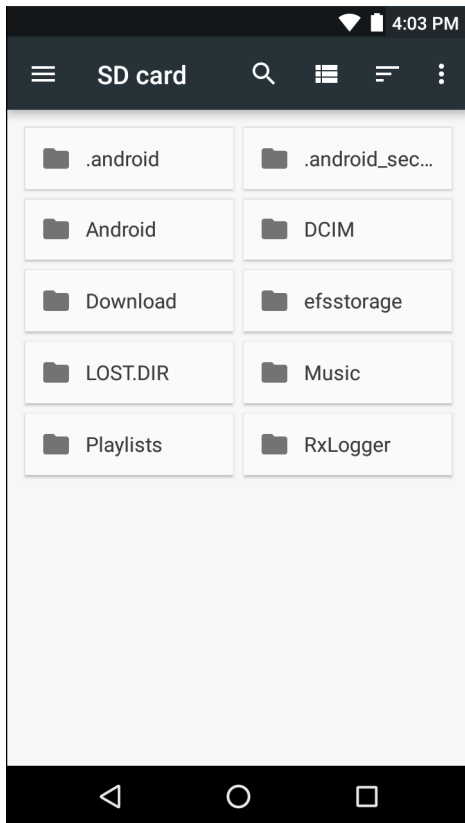
**Figure 143** Storage Screen

Portable storage displays the total amount of space on the installed microSD card and the amount used.

To unmount the microSD card, touch .

Touch **SD card** to view the contents of the card.

**Figure 144** SD Card Contents List

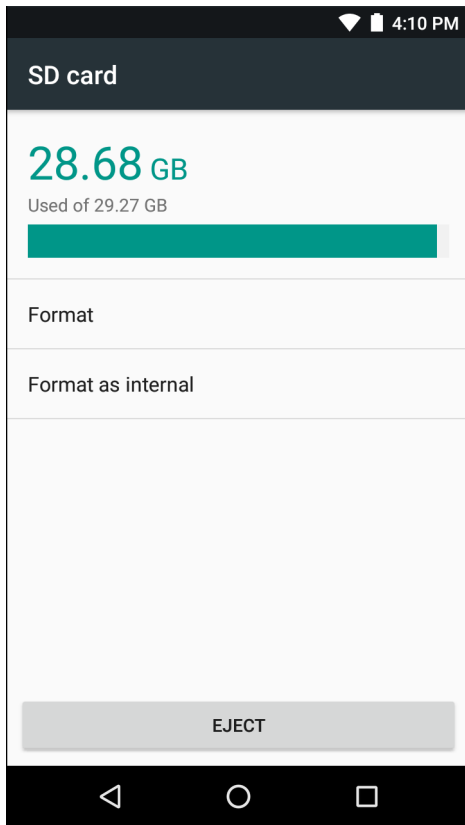


## Formatting a microSD Card

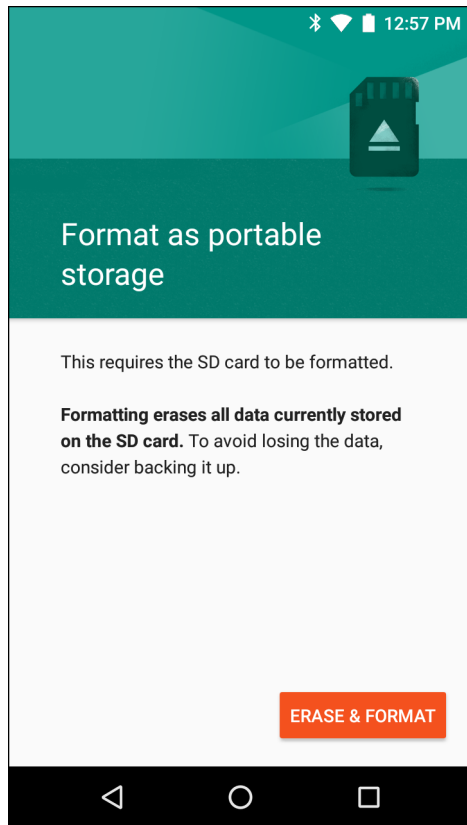
To format an installed microSD card as portable storage:

1. Touch **SD card**.
2. Touch **⋮** > **Settings**.

**Figure 145** SD Card Settings Screen



3. Touch **Format**.

**Figure 146** Format Screen

4. Touch **ERASE & FORMAT**.
5. Touch **DONE**.

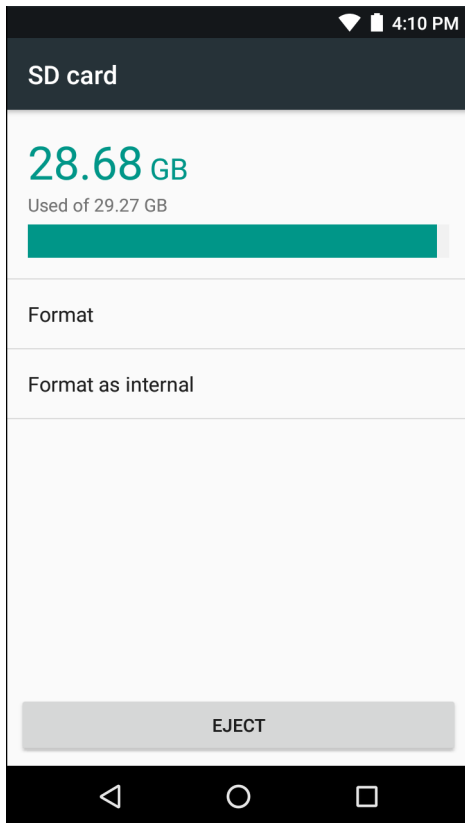
### Format as Internal Memory

You can format a microSD card as internal memory to increase the actual amount of the device's internal memory. Once formatted, the microSD card can only be read by this device. To format an installed microSD card as internal memory:

1. Touch **SD card**.
2. Touch **⋮ > Settings**.

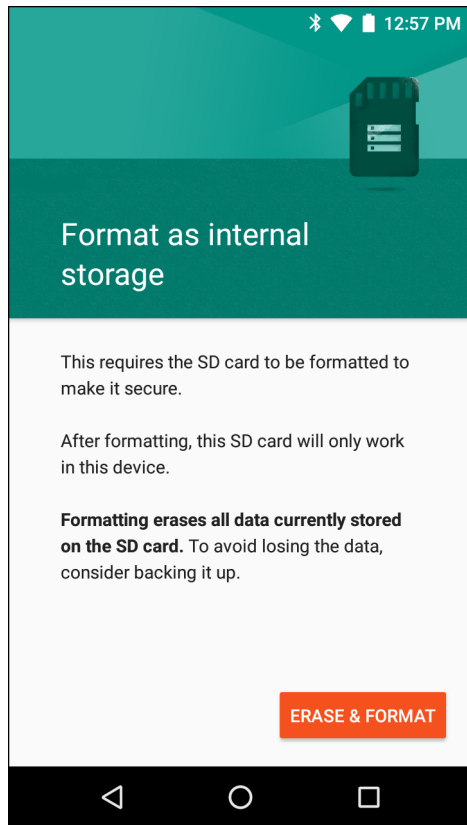


**Figure 147** SD Card Settings Screen



3. Touch **Format as internal**.

Figure 148 Format Screen



4. Touch **ERASE & FORMAT**.
5. Touch **DONE**.

## Enterprise Folder

The Enterprise folder (within internal flash) is a super-persistent storage that is persistent after a reset and an Enterprise Reset. The Enterprise folder is erased during a Factory Reset. The Enterprise folder is used for deployment and device-unique data. The Enterprise folder is approximately 128 MB (formatted). Applications can persist data after an Enterprise Reset by saving data to the enterprise/user folder. The folder is ext4 formatted and is only accessible from a host computer using ADB or from an MDM.

---

## Application Management

Applications use two kinds of memory: storage memory and RAM. Applications use storage memory for themselves and any files, settings, and other data they use. They also use RAM when they are running.



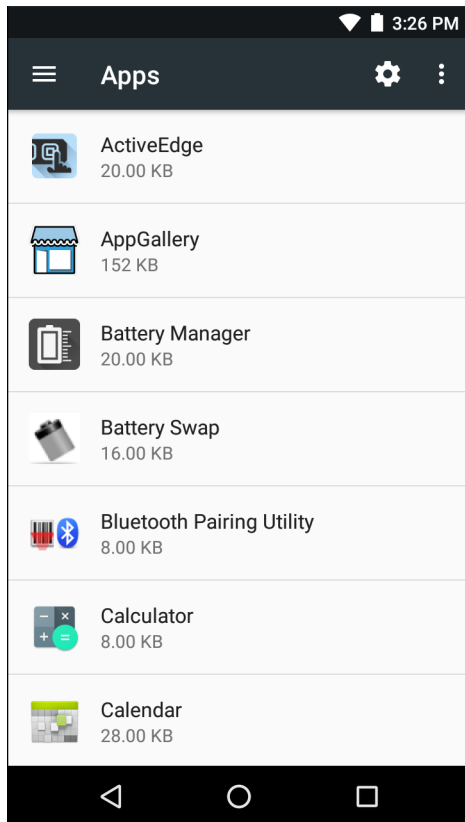
1. Swipe down with two fingers from the status bar to open the quick access panel and then touch .
2. Touch  **Apps**.

Figure 149 Apps Screen



Touch **⋮** > **Show system** to include system processes in the list.

Touch an application, process, or service in the list to open a screen with details about it and, depending on the item, to change its settings, permissions, notifications and to force stop or uninstall it.

## Viewing Application Details




Applications have different kinds of information and controls, but commonly include:

- **Force stop** - stop an application.
- **Disable** - disable an application.
- **Uninstall** - remove the application and all of its data and settings from the device. See [Uninstalling an Application on page 194](#) for information about uninstalling applications.
- **Storage** - lists how much information is stored, and includes a button for clearing it.
- **Data usage** - provides information about data (Wifi) consumed by an application.
- **Permissions** - lists the areas on the device that the application has access to.
- **Notifications** - set the application notification settings.
- **Open by default** - clears If you have configured an application to launch certain file types by default, you can clear that setting here.
- **Battery** - lists the amount of computing power used by the application.
- **Memory** - lists the average application memory usage.
- **Advanced**
  - **Draw over other apps** - allows an application to display on top of other applications.

---

## Managing Downloads

Files and applications downloaded using the Browser or Email are stored on microSD card in the Download directory. Use the Downloads application to view, open, or delete downloaded items.

1. Swipe the screen up and touch .
2. Touch an item to open it.
3. Touch headings for earlier downloads to view them.
4. Touch and hold an item, select items to delete and touch . The item is deleted from storage.
5. Touch  > **By name** or **By date modified** to switch between them.

When an application is opened, the other applications being used do not stop. The operating system and applications work together to ensure that applications not being used do not consume resources unnecessarily, stopping and starting them as needed. For this reason, there's no need to stop applications unless it is not functioning properly.

---

# Maintenance and Troubleshooting

---

## Introduction

This chapter includes instructions on cleaning and storing the device, and provides troubleshooting solutions for potential problems during operation.

---

## Maintaining the MC33XX

For trouble-free service, observe the following tips when using the MC33XX:

- Do not scratch the screen of the MC33XX. When working with the MC33XX, use a stylus or plastic-tipped pens intended for use with a touch-sensitive screen. Never use an actual pen or pencil or other sharp object on the surface of the MC33XX screen.
- The touch-sensitive screen of the MC33XX is glass. Do not drop the MC33XX or subject it to strong impact.
- Protect the MC33XX from temperature extremes. Do not leave it on the dashboard of a car on a hot day, and keep it away from heat sources.
- Do not store or use the MC33XX in any location that is dusty, damp, or wet.
- Use a soft lens cloth to clean the MC33XX. If the surface of the MC33XX screen becomes soiled, clean it with a soft cloth moistened with a diluted window-cleaning solution.
- Periodically replace the rechargeable battery to ensure maximum battery life and product performance. Battery life depends on individual usage patterns.
- A screen protector is applied to the MC33XX. Zebra recommends using this to minimize wear and tear. Screen protectors enhance the usability and durability of touch screen displays. Benefits include:
  - Protection from scratches and gouges
  - Durable writing and touch surface with tactile feel
  - Abrasion and chemical resistance
  - Glare reduction
  - Keeping the device's screen looking new
  - Quick and easy installation.

---

## Battery Safety Guidelines



**WARNING:** Failure to follow these guidelines may result in fire, explosion, or other hazard.

- The area in which the units are charged should be clear of debris and combustible materials or chemicals. Particular care should be taken where the device is charged in a non commercial environment.
- Follow battery usage, storage, and charging guidelines found in this guide.
- Improper battery use may result in a fire, explosion, or other hazard.
- To charge the mobile device battery, the battery and charger temperatures must be between +32 °F and +104 °F (0 °C and +40 °C)
- Do not use incompatible batteries and chargers. Use of an incompatible battery or charger may present a risk of fire, explosion, leakage, or other hazard. If you have any questions about the compatibility of a battery or a charger, contact Zebra Customer Support Center.
- Do not disassemble or open, crush, bend or deform, puncture, or shred.
- Severe impact from dropping any battery-operated device on a hard surface could cause the battery to overheat.
- Do not short circuit a battery or allow metallic or conductive objects to contact the battery terminals.
- Do not modify or remanufacture, attempt to insert foreign objects into the battery, immerse or expose to water or other liquids, or expose to fire, explosion, or other hazard.
- Do not leave or store the equipment in or near areas that might get very hot, such as in a parked vehicle or near a radiator or other heat source. Do not place battery into a microwave oven or dryer.
- Battery usage by children should be supervised.
- Please follow local regulations to properly dispose of used re-chargeable batteries.
- Do not dispose of batteries in fire.
- Seek medical advice immediately if a battery has been swallowed.
- In the event of a battery leak, do not allow the liquid to come in contact with the skin or eyes. If contact has been made, wash the affected area with large amounts of water and seek medical advice.
- If you suspect damage to your equipment or battery, contact Zebra Customer Support to arrange for inspection.

---

## Cleaning Instructions



**CAUTION:** Always wear eye protection.

Read warning label on compressed air and alcohol product before using.

If you have to use any other solution for medical reasons please contact the Global Customer Support Center for more information.



**WARNING:** Avoid exposing this product to contact with hot oil or other flammable liquids. If such exposure occurs, unplug the device and clean the product immediately in accordance with these guidelines.

### Approved Cleanser Active Ingredients

100% of the active ingredients in any cleaner must consist of one or some combination of the following: isopropyl alcohol or mild soap. Bleach products are known to corrode metals. Avoid allowing any bleach based product to come in contact with the metal electrical contacts on the device, the battery or the cradle.

### Harmful Ingredients

The following chemicals are known to damage the plastics on the device and should not come in contact with the device: ammonia solutions, compounds of amines or ammonia; acetone; ketones; ethers; aromatic and chlorinated hydrocarbons; aqueous or alcoholic alkaline solutions; ethanolamine; toluene; trichloroethylene; benzene; carbonic acid and TB-lysoform.

### Cleaning Instructions

Do not apply liquid directly to the device. Dampen a soft cloth or use pre-moistened wipes. Do not wrap the device in the cloth or wipe, but gently wipe the unit. Be careful not to let liquid pool around the display window or other places. Allow the unit to air dry before use.

### Special Cleaning Notes

Many vinyl gloves contain phthalate additives, which are often not recommended for medical use and are known to be harmful to the housing of the device. The device should not be handled while wearing vinyl gloves containing phthalates, or before hands are washed to remove contaminant residue after gloves are removed. If products containing any of the harmful ingredients listed above are used prior to handling the device, such as hand sanitizer that contain ethanolamine, hands must be completely dry before handling the device to prevent damage to the plastics.

### Cleaning Materials Required

- Alcohol wipes
- Lens tissue
- Cotton-tipped applicators
- Isopropyl alcohol
- Can of compressed air with a tube.

### Cleaning Frequency

The cleaning frequency is up to the customer's discretion due to the varied environments in which the mobile devices are used. They may be cleaned as frequently as required, but it is advisable to clean the camera window periodically when used in dirty environments to ensure optimum performance.

---

## Cleaning the MC33XX

### Housing

Using the alcohol wipes, wipe the housing including buttons.

### Display

The display can be wiped down with the alcohol wipes, but care should be taken not to allow any pooling of liquid around the edges of the display. Immediately dry the display with a soft, non-abrasive cloth to prevent streaking.

### Exit Window

Wipe the camera and exit window periodically with a lens tissue or other material suitable for cleaning optical material such as eyeglasses.

### Connector Cleaning

To clean the connectors:

1. Remove the main battery from mobile computer.
2. Dip the cotton portion of the cotton-tipped applicator in isopropyl alcohol.
3. Rub the cotton portion of the cotton-tipped applicator back-and-forth across the connector. Do not leave any cotton residue on the connector.
4. Repeat at least three times.
5. Use the cotton-tipped applicator dipped in alcohol to remove any grease and dirt near the connector area.
6. Use a dry cotton-tipped applicator and repeat steps 4 through 6.



**CAUTION:** Do not point nozzle at yourself and others, ensure the nozzle or tube is away from your face.

7. Spray compressed air on the connector area by pointing the tube/nozzle about ½ inch away from the surface.
8. Inspect the area for any grease or dirt, repeat if required.

### Cleaning Cradle Connectors

To clean the connectors on a cradle:

1. Remove the DC power cable from the cradle.
2. Dip the cotton portion of the cotton-tipped applicator in isopropyl alcohol.
3. Rub the cotton portion of the cotton-tipped applicator along the pins of the connector. Slowly move the applicator back-and-forth from one side of the connector to the other. Do not leave any cotton residue on the connector.
4. All sides of the connector should also be rubbed with the cotton-tipped applicator.



**CAUTION:** Do not point nozzle at yourself and others, ensure the nozzle or tube is away from your face.

5. Spray compressed air in the connector area by pointing the tube/nozzle about ½ inch away from the surface.
6. Remove any lint left by the cotton-tipped applicator.
7. If grease and other dirt can be found on other areas of the cradle, use a lint-free cloth and alcohol to remove.
8. Allow at least 10 to 30 minutes (depending on ambient temperature and humidity) for the alcohol to air dry before applying power to cradle.

If the temperature is low and humidity is high, longer drying time is required. Warm temperature and dry humidity requires less drying time.



## Troubleshooting SmartMU

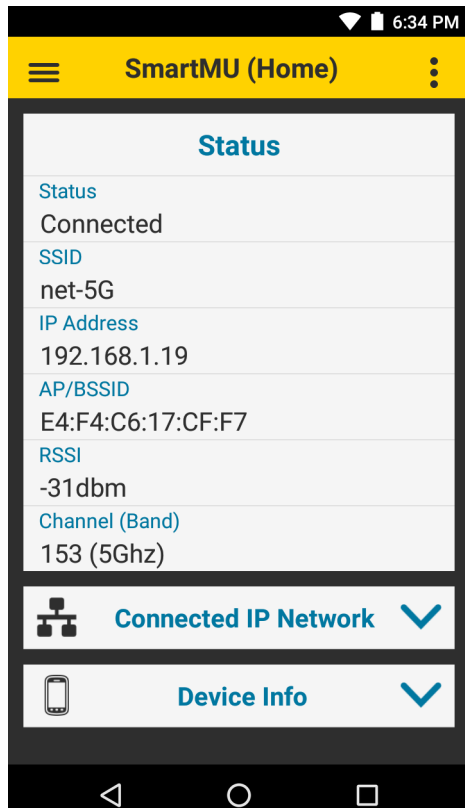


**NOTE:** This section applies to a device with LifeGuard Update 08 or earlier.

On a device with LifeGuard Update 09 or later, refer to the SmartMU Administrator Guide at: [www.zebra.com/support](http://www.zebra.com/support).

The SmartMU application provides WLAN network connectivity analysis for troubleshooting connection issues.

**Figure 150** SmartMU Screen



### Camera Preview



**NOTE:** Camera Preview is available on device configurations that include a camera.

When Camera Preview is enabled, a live camera view appears on the screen and remains active while SmartMU is open.

To enable the Camera Preview feature from any screen in SmartMU, touch **☰ > Camera Preview**. To disable, touch **☰ > Camera Preview** or touch the X on the top right of the camera view. To move the box, touch and drag anywhere on the screen area.

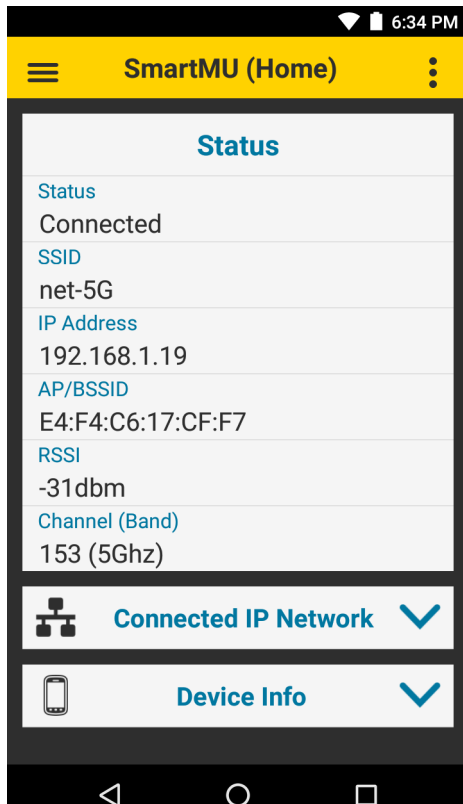
To capture a screenshot, simultaneously press and hold the power key and the volume down key at the same time. The entire screen, including the SmartMU application and camera preview are saved to the device storage as a PNG file.

## Home Screen

The Home screen displays:

- Status
- Connected IP Network
- Device information.

**Figure 151** Home Screen



### Status

Displays the current device status.

- **Status** - indicates the current connection status.
- **SSID** - displays the WLAN network the device is connected to.
- **IP Address** - displays the IP address of the device.
- **AP/BSSID** - displays the BSSID of the connected access point.
- **RSSI** - displays the RSSI of the connected access point.
- **Channel (Band)** - displays the channel.

### Connected IP Network

To view details of the connected IP network, touch the down arrow next to **Connect IP Network**. The following IP network information displays:

- **Gateway** - displays the IP address of the network gateway.
- **DHCP Server** - displays the IP address of the DHCP server.

- **Lease Duration** - displays the amount of time the device is allowed to connect to the DHCP server with the current dynamic IP address.
- **Netmask** - displays the server subnet mask address.
- **DNS1** - displays the Domain Name System 1 (DNS1) address.
- **DNS2** - displays the DNS2 address.

## Device Information

To view device information, touch the down arrow next to **Device Info**. The following device information displays:

- **Device Product Name** - displays the device name.
- **Device MAC** - displays the device MAC address.
- **Operating System** - displays the device operating system version.

## Scan List

The Scan List displays a list of available networks (SSIDs) found in the in the immediate vicinity of the device sorted by signal strength.

**Figure 152** Scan List

The screenshot shows a mobile application interface titled "Scan List". At the top, there is a yellow header bar with a menu icon on the left and a three-dot menu icon on the right. Below the header is a blue bar with the text "Select Filter Options" and a right-pointing arrow. The main content is a table with the following columns: SSID, BSSID, RSSI, and Channel / Band. The table lists several networks, with "Guest Connected" highlighted in blue. Each row has a right-pointing arrow next to the Channel / Band information.

SSID	BSSID	RSSI	Channel / Band
Guest Connected	74:67:f7:0b:24:b2	-55	153 /5G
Engineer	74:67:f7:0b:24:b5	-55	153 /5G
EWireless	74:67:f7:0b:24:b4	-55	153 /5G
Scan	74:67:f7:0b:24:b3	-55	153 /5G
Corp	74:67:f7:0b:24:b1	-55	153 /5G
Wireless	74:67:f7:0b:24:b0	-55	153 /5G
Wireless	84:24:8d:af:06:50	-58	11 /2.4G
Corp	84:24:8d:ae:6a:41	-70	149 /5G

For each network, the following displays:

- **SSID** - displays the primary name associated with an 802.11 wireless local area network (WLAN).
- **BSSID** - displays the MAC address of access point.
- **RSSI** - displays the relative received signal strength in a wireless environment. The higher the RSSI number, the stronger the signal.

- **Channel/Band** - displays the channel and frequency band.

### Filter Options

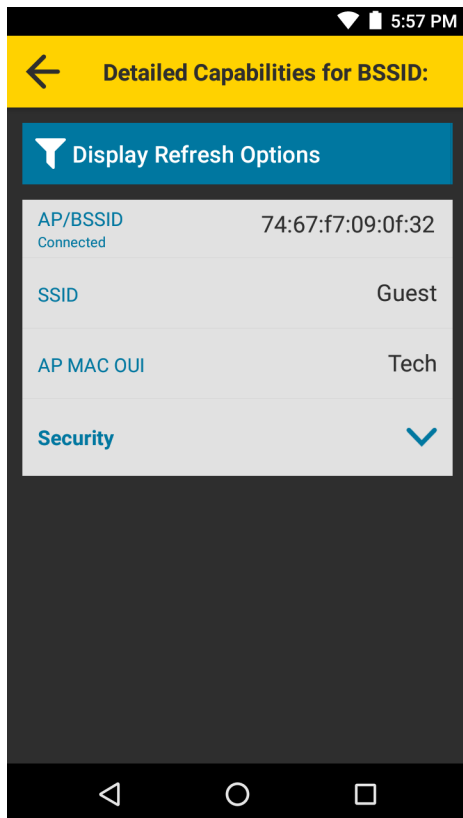
From the **Scan List** screen, touch **Select Filter Options** to filter on networks.

- **Modify Filtering Options** - select to filter the Scan List using one of the following options:
  - **All SSID** - display all SSIDs (default)
  - **Connected SSID** - display connected SSIDs.
  - **Filter by SSIDs** - Touch to display a list of SSIDs. Select an SSID to enable or disable view of it in the Scan List.
- **Sort By** - select to sort the Scan List by **Received Signal Strength (RSSI)** (default), or **Channel**.
- **Group by SSID** - select to sort the Scan List by grouping SSIDs with the same name together. SSIDs are listed in alphabetical order.

### Detailed Capabilities for BSSID

From the **Scan List** screen, touch a network to display detailed capabilities for the selected network.

**Figure 153** Detailed Capabilities for BSSID



- **AP/BSSID** - displays the BSSID of the connected access point.
- **SSID** - displays the WLAN network the device is connected to.
- **AP MAC OUI** - displays the Organizationally Unique Identifier (OUI).

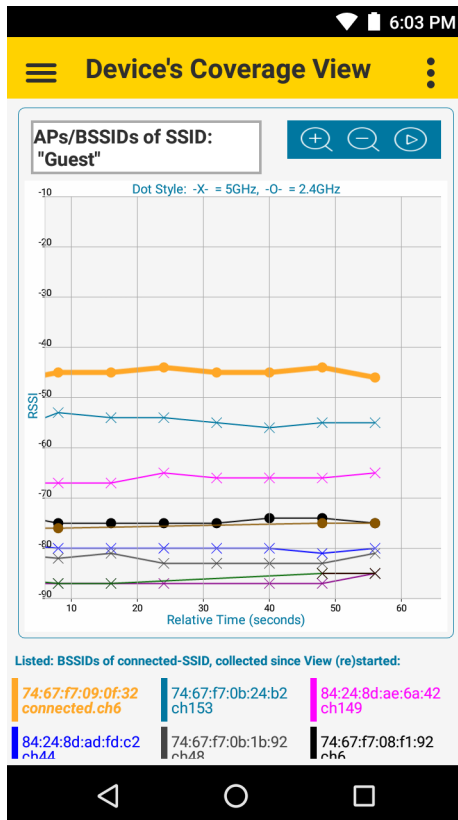
- **Security** - Touch the down arrow next to **Security** to view security WLAN information.

Use **Display Refresh Options** to automatically refresh the detailed capabilities information. Touch **Display Refresh Options** and use the toggle button to disable or enable automatic refresh.

## Device Coverage View

Device coverage view displays BSSIDs plots of the connected-SSID vs relative time (in seconds).

**Figure 154** Device's Coverage View



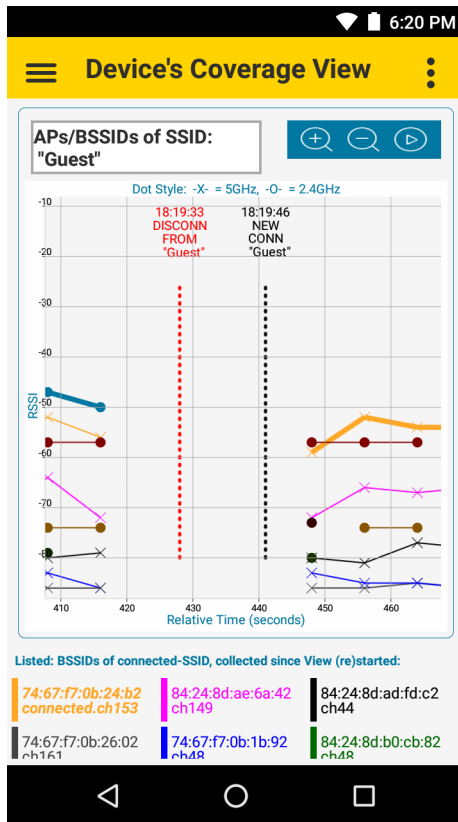
Each line is a connected BSSID. The Dotting marks are the RSSI values from scan samples.

The legend view at the bottom of the screen matches each BSSID to a color and specifies the currently connected BSSID. The BSSID colors also display as vertical bars on the Scan List screen.

Vertical dotted lines designate events which can happen outside of regular scan intervals:

- **VIEW (RE)STARTED** – view started with no actual Connectivity or Roam event involved.
- **ROAMED** – AP hand-off event.
- **DISCONN** – disconnection from SSID.
- **NEW CONN** – connection to SSID

Figure 155 Device's Coverage View Events



To zoom in and out, place two fingers on the screen and pinch them together (to zoom out) or spread them apart (to zoom in), or touch the and icons. Pan in any direction inside the graph by moving a finger on the screen. If Zoom or Pan is used, auto-scroll is paused. Touch icon to enable auto-scroll. Samples are recorded even if not in viewing area.

### Auto Reachability Test

When Auto-Reachability Test is enabled, at fixed intervals after Conn/Roam events, four ICMP packets are sent to the Gateway IP address. Touch > **Auto Reachability Test** and use the toggle button to enable or disable Auto Reachability Test.

### Networking Tools

To view available networking tools, touch the down arrow next to **Networking Tools**.

#### Ping

Ping is a network utility that sends an ICMP ping with configurable input settings for up to two IP addresses or URLs at the same time.

Figure 156 Ping Screen



### Ping Settings

Ping Settings provides options for configuring ping input settings. To configure ping input settings, touch .

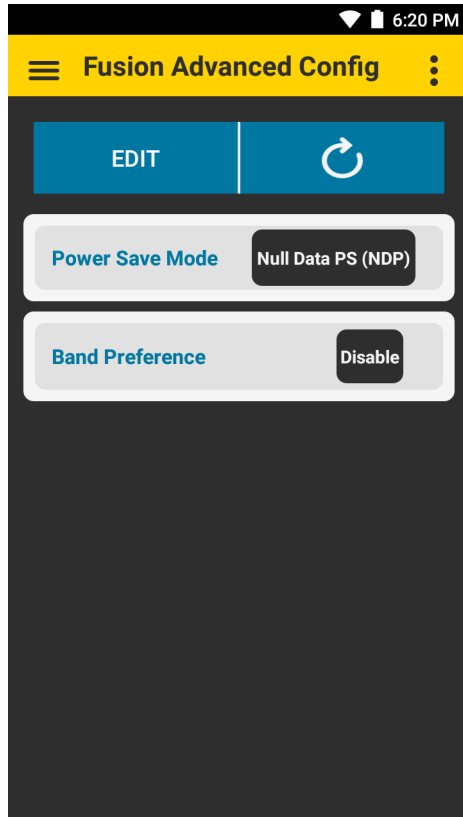
- **Continuous ping** - Enable or disable continuous ping (default - disabled).
- **Count** - specifies the number of ping requests to send (default - 10). This option is not available when using continuous ping.
- **Interval (ms)** - specifies the amount of time in ms between ping requests (default - 1000).
- **Packet Size** - specifies the size of each ping packet in bytes (default - 64).

## Fusion Advanced Configuration

Use the Fusion Advanced Configuration screen to select a power save mode or set a band preference.

A password is required to access settings in Fusion Advanced Configuration. In SmartMU full version, use the SmartMU security application and an Mobile Device Manager (MDM) intent. In SmartMU lite, use the default password ?gUpD!8(.

**Figure 157** Fusion Advanced Config Screen



After entering the password, the following options are available:

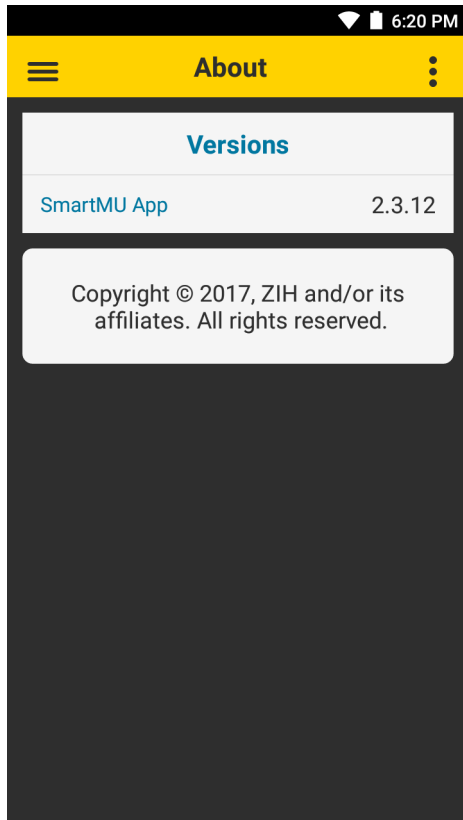
- Power Save Mode
  - Active (CAM)
  - WMM-PS
  - Null Data PS (NDP) (default)
  - PS Poll
- Band Preference
  - Disable (default)
  - Prefer 2.4 GHz
  - Prefer 5 GHz



## About

Displays the applications version number.

**Figure 158** About Screen





## Troubleshooting



The following tables provides typical problems that might arise and the solution for correcting the problem.

### Troubleshooting the MC33XX

**Table 12** Troubleshooting the MC33XX

Problem	Cause	Solution
Mobile computer does not turn on.	Main battery not charged.	Charge or replace the main battery.
	Main battery not installed properly.	Ensure the battery is installed properly.
	MC33XX not responding.	Perform a soft reset. If the mobile computer still does not turn on, perform a hard reset. For more information see <a href="#">Resetting the Device on page 26</a> .
Battery did not charge.	Battery failed.	Replace battery. If the mobile computer still does not operate, try a soft reset, then a hard reset. See <a href="#">Getting Started on page 19</a> .
	Mobile computer removed from cradle while battery was charging.	Insert mobile computer in cradle and begin charging. If a battery is fully depleted, it can take up to 2.2 hours to fully recharge a 2740 mAh PowerPrecision+ standard battery and it can take up to 3.8 hours to fully recharge a 5200 mAh PowerPrecision+ extended battery.
	Extreme battery temperature.	Battery does not charge if ambient charging temperature of the battery is below 32 °F (0 °C) or above 104 °F (40 °C).
Cannot see characters on screen.	Mobile computer not powered on.	Press the Power button.
During data communication, no data was transmitted, or transmitted data was incomplete.	Mobile computer removed from cradle or unplugged from host computer during communication.	Replace the mobile computer in the cradle, or reattach the cable and re-transmit.
	Incorrect cable configuration.	See the system administrator.
Mobile computer does not emit sound.	Volume setting is low or turned off.	Click on the speaker icon to increase the volume.
MC33XX turns itself off.	MC33XX is inactive.	The mobile computer turns off after a period of inactivity. This period can be set from 15 seconds to 30 minutes.
	Battery is depleted.	Recharge or replace the battery.
A message appears stating that the mobile computer memory is full.	Too many applications installed on the mobile computer.	Remove user-installed applications on the MC33XX to recover memory. Select  >  <b>Apps</b> . Select the unused programs and touch <b>Uninstall</b> .

**Table 12** Troubleshooting the MC33XX (Continued)

Problem	Cause	Solution
The MC33XX does not decode when reading barcode.	DataWedge is not enabled.	Ensure that DataWedge is enabled and configured properly.
	Unreadable barcode.	Ensure the symbol is not defaced.
	Distance between the MC33XX and barcode is incorrect.	Place the MC33XX within proper scanning range.
	MC33XX is not programmed for the barcode type.	Program the MC33XX to accept the type of barcode being scanned.
	MC33XX is not programmed to generate a beep.	If the MC33XX does not beep on a good decode, set the application to generate a beep on good decode.
MC33XX cannot find any Bluetooth devices nearby.	Too far from other Bluetooth devices.	Move closer to the other Bluetooth device(s), within a range of 10 meters (32.8 feet).
	The Bluetooth device(s) nearby are not turned on.	Turn on the Bluetooth device(s) to find.
	The Bluetooth device(s) are not in discoverable mode.	Set the Bluetooth device(s) to discoverable mode. If needed, refer to the device's user documentation for help.
Cannot connect to WLAN (on channels 12-13 and all 5GHz channels).	Access Point (AP) does not broadcast country code.	Disable 802.11d feature. Touch  > <b>Wi-Fi</b> >  > <b>Additional settings</b> > <b>Country Selection</b> . A warning window pops up indicating you must select the country in which you are using the device. This enables all channels for the selected country even if the AP does not broadcast country code.
When trying to open File Browser or other applications, the application automatically closes.	The Internal Memory is full.	Connect the MC33XX to a host computer and delete files from Internal Memory using the host computer.

## 1-Slot USB Charge Cradle Troubleshooting

**Table 13** Troubleshooting the 1-Slot USB Charge Cradle





Problem	Cause	Solution
MC33XX Charge LED Indicator does not light when MC33XX inserted.	Cradle is not receiving power.	Ensure the power cable is connected securely to both the cradle and to AC power.
	MC33XX is not correctly seated.	Remove and re-insert the MC33XX into the cradle, ensuring it is correctly seated.

**Table 13** Troubleshooting the 1-Slot USB Charge Cradle (Continued)

Problem	Cause	Solution
Spare Battery Charging LED does not light when spare battery is inserted.	Spare battery not correctly seated.	Remove and re-insert the spare battery into the cradle, ensuring it is correctly seated.
MC33XX battery is not charging.	MC33XX was removed from cradle or cradle was unplugged from AC power too soon.	Ensure cradle is receiving power. Ensure the MC33XX is seated correctly. If a battery is fully depleted, it can take up to 2.2 hours to fully recharge a 2740 mAh PowerPrecision+ standard battery and it can take up to 3.8 hours to fully recharge a 5200 mAh PowerPrecision+ extended battery.
	Battery is faulty.	Verify that other batteries charge properly. If so, replace the faulty battery.
	The MC33XX is not fully seated in the cradle.	Remove and re-insert the MC33XX into the cradle, ensuring it is firmly seated.
	Extreme battery temperature.	Battery does not charge if ambient temperature is below 0 °C (32 °F) or above 40 °C (104 °F).
Spare battery is not charging.	Battery not fully seated in charging slot.	Remove and re-insert the spare battery into the cradle, ensuring it is correctly seated.
	Battery inserted incorrectly.	Ensure the contacts are facing down and toward the back of the cradle.
During data communication, no data was transmitted, or transmitted data was incomplete.	MC33XX removed from cradle during communication.	Replace MC33XX in cradle and retransmit.
	Incorrect cable configuration.	See the system administrator.
	Communication software is not installed or configured properly.	See the system administrator.





## 5-Slot Charge Only ShareCradle Troubleshooting

**Table 14** Troubleshooting the 5-Slot Charge Only ShareCradle

Problem	Cause	Solution
Mobile computer Charge LED Indicator does not light when mobile computer inserted.	Cradle is not receiving power.	Replace the MC33XX in the cradle. Touch  >  <b>About device</b> > <b>Status</b> to view battery status.
	Battery is faulty.	Verify that other batteries charge properly. If so, replace the faulty battery.
	MC33XX is not inserted correctly in the cradle.	Remove the MC33XX and reinsert it correctly. Verify charging is active. Touch  >  <b>About device</b> > <b>Status</b> to view battery status.
	Ambient temperature of the cradle is too warm.	Move the cradle to an area where the ambient temperature is between 0 °C (32 °F) and 35 °C (95 °F).
Mobile computer Charge LED indicator is a fast blinking red when mobile computer inserted.	Ambient temperature of the cradle is too low or too high.	Move the cradle to an area where the ambient temperature is between 0 °C (32 °F) and 35 °C (95 °F).
	Charging has gone on too long without completion (typically eight hours).	Verify that other batteries charge properly. If so, replace the faulty battery.

## 5-Slot Ethernet ShareCradle Troubleshooting

**Table 15** Troubleshooting the 5-Slot Ethernet ShareCradle





Problem	Cause	Solution
Mobile computer Charge LED Indicator does not light when mobile computer inserted.	Cradle is not receiving power.	Replace the MC33XX in the cradle. Touch  >  <b>About device</b> > <b>Status</b> to view battery status.
	Battery is faulty.	Verify that other batteries charge properly. If so, replace the faulty battery.
	MC33XX is not inserted correctly in the cradle.	Remove the MC33XX and reinsert it correctly. Verify charging is active. Touch  >  <b>About device</b> > <b>Status</b> to view battery status.
	Ambient temperature of the cradle is too warm.	Move the cradle to an area where the ambient temperature is between 0 °C (32 °F) and 35 °C (95 °F).

**Table 15** Troubleshooting the 5-Slot Ethernet ShareCradle (Continued)

Problem	Cause	Solution
Mobile computer Charge LED indicator is a fast blinking red when mobile computer inserted.	Ambient temperature of the cradle is too low or too high.	Move the cradle to an area where the ambient temperature is between 0 °C (32 °F) and 35 °C (95 °F).
	Charging has gone on too long without completion (typically eight hours).	Verify that other batteries charge properly. If so, replace the faulty battery.





## 5-Slot ShareCradle with 4-Slot Battery Charger Troubleshooting

**Table 16** Troubleshooting the 5-Slot ShareCradle with 4-Slot Battery Charger

Problem	Cause	Solution
Mobile computer Charge LED Indicator does not light when mobile computer inserted.	Cradle is not receiving power.	Replace the MC33XX in the cradle. Touch  >  <b>About device</b> > <b>Status</b> to view battery status.
	Battery is faulty.	Verify that other batteries charge properly. If so, replace the faulty battery.
	MC33XX is not inserted correctly in the cradle.	Remove the MC33XX and reinsert it correctly. Verify charging is active. Touch  >  <b>About device</b> > <b>Status</b> to view battery status.
	Ambient temperature of the cradle is too warm.	Move the cradle to an area where the ambient temperature is between 0 °C (32 °F) and 35 °C (95 °F).
Mobile computer Charge LED indicator is a fast blinking red when mobile computer inserted.	Ambient temperature of the cradle is too low or too high.	Move the cradle to an area where the ambient temperature is between 0 °C (32 °F) and 35 °C (95 °F).
	Charging has gone on too long without completion (typically eight hours).	Verify that other batteries charge properly. If so, replace the faulty battery.
Spare Battery Charging LED does not light when spare battery is inserted.	Spare battery not correctly seated.	Remove and re-insert the spare battery into the cradle, ensuring it is correctly seated.
Spare battery is not charging.	Battery not fully seated in charging slot.	Remove and re-insert the spare battery into the cradle, ensuring it is correctly seated.
	Battery inserted incorrectly.	Ensure the contacts are facing down and toward the back of the cradle.

## 5-Slot Ethernet ShareCradle with 4-Slot Battery Charger Troubleshooting

**Table 17** Troubleshooting the 5-Slot Ethernet ShareCradle with 4-Slot Battery Charger

Problem	Cause	Solution
Mobile computer Charge LED Indicator does not light when mobile computer inserted.	Cradle is not receiving power.	Replace the MC33XX in the cradle. Touch  >  <b>About device</b> > <b>Status</b> to view battery status.
	Battery is faulty.	Verify that other batteries charge properly. If so, replace the faulty battery.
	MC33XX is not inserted correctly in the cradle.	Remove the MC33XX and reinsert it correctly. Verify charging is active. Touch  >  <b>About device</b> > <b>Status</b> to view battery status.
	Ambient temperature of the cradle is too warm.	Move the cradle to an area where the ambient temperature is between 0 °C (32 °F) and 35 °C (95 °F).
Mobile computer Charge LED indicator is a fast blinking red when mobile computer inserted.	Ambient temperature of the cradle is too low or too high.	Move the cradle to an area where the ambient temperature is between 0 °C (32 °F) and 35 °C (95 °F).
	Charging has gone on too long without completion (typically eight hours).	Verify that other batteries charge properly. If so, replace the faulty battery.
Spare Battery Charging LED does not light when spare battery is inserted.	Spare battery not correctly seated.	Remove and re-insert the spare battery into the cradle, ensuring it is correctly seated.
Spare battery is not charging.	Battery not fully seated in charging slot.	Remove and re-insert the spare battery into the cradle, ensuring it is correctly seated.
	Battery inserted incorrectly.	Ensure the contacts are facing down and toward the back of the cradle.

## 4-Slot Spare Battery Charger Troubleshooting

**Table 18** Troubleshooting the 4-Slot Spare Battery Charger

Problem	Cause	Solution
Spare Battery Charging LED does not light when spare battery is inserted.	Spare battery is not correctly seated.	Remove and re-insert the spare battery into the charging slot, ensuring it is correctly seated.

**Table 18** Troubleshooting the 4-Slot Spare Battery Charger (Continued)

Problem	Cause	Solution
Spare Battery not charging.	Charger is not receiving power.	Ensure the power cable is connected securely to both the charger and to AC power.
	Spare battery is not correctly seated.	Remove and re-insert the battery into the cradle, ensuring it is correctly seated.
	Battery was removed from the charger or charger was unplugged from AC power too soon.	Ensure charger is receiving power. Ensure the spare battery is seated correctly. If a battery is fully depleted, it can take up to 2.2 hours to fully recharge a 2740 mAh PowerPrecision+ standard battery and it can take up to 3.8 hours to fully recharge a 5200 mAh PowerPrecision+ extended battery.
	Battery is faulty.	Verify that other batteries charge properly. If so, replace the faulty battery.

## 20-Slot Spare Battery Charger Troubleshooting

**Table 19** Troubleshooting the 20-Slot Spare Battery Charger

Problem	Cause	Solution
Spare Battery Charging LED does not light when spare battery is inserted.	Spare battery is not correctly seated.	Remove and re-insert the spare battery into the charging slot, ensuring it is correctly seated.
Spare Battery not charging.	Charger is not receiving power.	Ensure the power cable is connected securely to both the charger and to AC power.
	Spare battery is not correctly seated.	Remove and re-insert the battery into the cradle, ensuring it is correctly seated.
	Battery was removed from the charger or charger was unplugged from AC power too soon.	Ensure charger is receiving power. Ensure the spare battery is seated correctly. If a battery is fully depleted, it can take up to 3 hours to fully recharge a 2740 mAh PowerPrecision+ standard battery and it can take up to 5.5 hours to fully recharge a 5200 mAh PowerPrecision+ extended battery.
	Battery is faulty.	Verify that other batteries charge properly. If so, replace the faulty battery.

## USB Charge Cable

**Table 20** Troubleshooting the USB Charge Cable

Symptom	Possible Cause	Action
MC33XX Charge LED Indicator does not light when MC33XX is attached.	Cable is not receiving power.	Ensure the power cable is connected securely to both the cable and to AC power.
	MC33XX is not seated correctly in the cable cup.	Remove and re-insert the MC33XX into the MC33XX cable cup, ensuring it is correctly seated.



**Table 20** Troubleshooting the USB Charge Cable (Continued)

Symptom	Possible Cause	Action
MC33XX battery is not charging.	MC33XX was detached from cable or cable was unplugged from AC power too soon.	Ensure the cable is receiving power. Ensure MC33XX is seated correctly. If a battery is fully depleted, it can take up to 2.2 hours to fully recharge a 2740 mAh PowerPrecision+ standard battery and it can take up to 6 hours to fully recharge a 5200 mAh PowerPrecision+ extended battery.
	Battery is faulty.	Verify that other batteries charge properly. If so, replace the faulty battery.
	The MC33XX is not fully seated in the cable.	Remove and re-insert the MC33XX into the cable cup, ensuring it is correctly seated.
During data communication, no data transmits, or transmitted data was incomplete.	Cable was disconnected from MC33XX during communications.	Re-attach the cable and retransmit.
	Incorrect cable configuration.	See the system administrator.
	Communication software is not installed or configured properly.	See the system administrator.

# Technical Specifications

---

## Introduction

The following sections provide technical specification for the device.

---

## MC33XX Technical Specifications

The following table summarizes the MC33XX's intended operating environment and technical hardware specifications.

**Table 21** MC33XX Technical Specifications

Item	Description
<b>Physical Characteristics</b>	
Dimensions	MC33XX-G: 202.6 mm L x 74.7 mm W x 163.9 mm H (7.96 in L x 2.94 in W x 6.45 in D) MC33XX-S: (202.2 mm L x 74.7 mm W x 34.5 mm D) 7.96 in L x 2.94 in W x 1.35 in D MC33XX-R: 8.79 in L x 2.94 in W x 1.35 in D (223.4 mm L x 74.7 mm W x 34.5 mm D) MC33XX-45: 7.96 in L x 2.94 in W x 1.35 in D 202.2 mm L x 74.7 mm W x 34.5 mm D
Weight	MC33XX-G (with extended battery) - 505 g (17.8 oz) MC33XX-R (with standard battery) - 13.3 oz (377 g) MC33XX-S (with standard battery) - 13.2 oz (375 g) MC33XX-45 (with standard battery) - 13.5 oz (382 g)
Display	4.0 inch capacitive; WVGA; color
Imager Window	Corning® Gorilla® Glass

## Technical Specifications

**Table 21** MC33XX Technical Specifications (Continued)

Item	Description
Touch Panel	Corning® Gorilla® Glass touch panel w/air gap
Backlight	LED backlight
Battery	Standard: Rechargeable Lithium-Ion 2740 mAh minimum (3.7V) Extended Life: Rechargeable Lithium-Ion 5200 mAh minimum (3.7V)
Expansion Slot	User accessible microSD slot. Supports up to 32 GB microSDHC.
Network Connections	USB 2.0 High Speed (host and client), WLAN and Bluetooth
Notification	Side LEDs and audible tone.
Keypad Options	29-key Numeric 38-key Function Numeric (calculator-style integrated numeric keypad) 47-key Alpha-Numeric (calculator-style integrated numeric keypad)
Voice	PTT Voice Support (Internal Speaker)
Audio	Speaker
Audio Jack (Premium/Premium +)	MC33XX-S, MC33XX-R, MC33XX-45: Integrated 2.5 mm
Buttons	MC33XX-S, MC33XX-R, MC33XX-45: Two Scan Side Keys (programmable)
<b>Performance Characteristics</b>	
CPU	Qualcomm 8956 1.8 GHz hexa-core 64-bit with power optimization
Operating System	Android-based AOSP (7.1.2); GMS (7.1.2) select configurations
Memory	Standard: 2 GB RAM/16 GB Flash. Premium: 4 GB RAM/16 GB Flash. Premium +: 4 GB RAM/32 GB Flash.
Output Power (USB)	USB: 5 VDC @ 500 mA max.
<b>User Environment</b>	
Operating Temperature	-20°C to 50°C (-4°F to 122°F)
Storage Temperature	-40°C to 70°C (-40°F to 158°F) without battery
Charging Temperature	0°C to 40°C (32°F to 104°F)
Humidity	5% to 95% RH non-condensing
Drop Specification	Multiple 1.5 m (5 ft.) drops to concrete over the entire operating temperature range.
Tumble Specification	500 drops 1 m (3.2 ft.) Tumbles (1000 hits)

## Technical Specifications

**Table 21** MC33XX Technical Specifications (Continued)

Item	Description
Sealing	IP54
Vibration	5 Hz to 2 KHz
Thermal Shock	-40°C to 70°C (-40°F to 158°F)
Electrostatic Discharge (ESD)	±20 kVdc air discharge, ± 10 kVdc contact discharge
<b>Wireless LAN Data Communications</b>	
Wireless Local Area Network (WLAN) radio	IEEE® 802.11a/b/g/n/ac/d/h/i/k/r/w
Data Rates Supported	2.4 GHz: 144 Mbps 5 GHz: 867 Mbps
Operating Channels	Chan 36 - 165 (5 GHz), Chan 1 - 13 (2.4 GHz); actual operating channels/frequencies depend on regulatory rules and certification agency.
Security and Encryption	<b>Security Modes:</b> WPA and WPA2 (Personal or Enterprise) <b>Encryption:</b> WEP40/WEP104, TKIP and AES <b>Authentication:</b> EAP-TLS; EAP-TTLS (MSCHAP, MSCHAPv2, PAP); PEAP (MSCHAPv2, EAP-GTC); LEAP <b>Other:</b> Wi-Fi certified, and supports IPv6 Data in Motion: FIPS 140-2 Level 1 Data at Rest: FIPS 140-2 Level 1
Certifications	802.11n/ac, WMM-PS, WMM-AC, PMF, Voice Enterprise, Wi-Fi Direct, WPS
Fast Roam	PMKID/OKC/CCKM/802.11r
<b>Wireless PAN Data</b>	
Bluetooth	V4.1, V2.1 + EDR w/ Bluetooth Low Energy (BLE). Class 2
<b>Data Capture</b>	
Scanning	MC33XX-S: SE965 1D, SE4750 SR 2D, SE4850 ERI MC33XX-R: SE965 1D Laser MC33XX-G: SE965 1D, SE4750 SR 2D, SE4850 ERI MC33XX-45: SE4750 SR 2D
Rear Camera (13 MP) with Flash	MC33XX-S, MC33XX-R, MC33XX-45: Available on Premium +
NFC	ISO14443 Type A&B, ISO15693 and Felica cards. Peer to Peer mode and Card Emulation via Host (HCE) Available on Premium/Premium + only.
<b>Laser Scanner (SE965) Specifications</b>	
Optical Resolution	0.005 in. minimum element width

## Technical Specifications

**Table 21** MC33XX Technical Specifications (Continued)

Item	Description
Roll	Condition: 20 mil Code 39 at 10 in. ± 35° from vertical
Pitch Angle	Condition: 20 mil Code 39 at 10 in. ± 65° from normal
Skew Tolerance	Condition: 20 mil Code 39 at 10 in. ± 40° from normal
Ambient Light	Tolerant to typical artificial indoor and natural outdoor (direct sunlight) lighting conditions. Fluorescent, Incandescent, Mercury Vapor, Sodium Vapor, LED: 450 ft. Candles (4,844 Lux) Sunlight: 10,000 Ft Candles (107,640 Lux) Note: LED lighting with high AC ripple content can impact scanning performance.
Scan Repetition Rate	104 (± 14) scans/sec (bidirectional)
Scan Angle	Wide (Default): 47° (typical) Medium: 35° (typical) Narrow: 10° (typical)
<b>2D Imager Engine (SE4750) Specifications</b>	
Field of View	Horizontal - 48.0° Vertical - 36.7°
Image Resolution	1280 horizontal X 960 vertical pixels
Roll	360°
Pitch Angle	+/- 60° from normal
Skew Tolerance	+/- 60° from normal
Ambient Light	Sunlight: 10,000 ft. candles (107,639 lux)
Focal Distance	From front of engine: 17.7 cm (7.0 in.)
Laser Aiming Element	Visible Laser Diode (VLD): 655 nm +/- 10 nm Central Dot Optical Power: 0.6 mW (typical) Pattern Angle: 48.0° horizontal, 38.0° vertical
Illumination System	LEDs: Warm white LED Pattern Angle: 80° at 505 intensity
<b>2D Extended Range Imager Engine (SE4850) Specifications</b>	
Field of View	Near camera: Horizontal - 32.0°, Vertical 20° Far camera: Horizontal - 12°, Vertical - 7.6°
Image Resolution	1280 horizontal X 800 vertical pixels

## Technical Specifications

**Table 21** MC33XX Technical Specifications (Continued)

Item	Description
Roll	360°
Pitch Angle	+/- 60° from normal
Skew Tolerance	+/- 60° from normal
Ambient Light	Sunlight: 10,000 ft. candles (107,639 lux)
Laser Aiming Element	Laser Wavelength: 655 nm Central Dot Optical Power: 0.6 mW (Class 2 IEC60825:2014)
Illumination System	LEDs: Hyper Red 660nm
<b>Supported Symbologies</b>	
1D	Chinese 2 of 5, Codabar, Code 11, Code 128, Code 39, Code 93, Discrete 2 of 5, EAN-8, EAN-13, GS1 DataBar, GS1 DataBar Expanded, GS1 DataBar Limited, Interleaved 2 of 5, Korean 2 of 5, MSI, TLC 39, Matrix 2 of 5, Trioptic, UPCA, UPCE, UPCE1, Web Code.
2D	Australian Postal, Aztec, Canadian Postal, Composite AB, Composite C, Data Matrix, Dutch Postal, Japan Postal, Maxicode, Micro PDF, Micro QR, PDF, QR Code, UK Postal, US Planet, US Postnet, US4State, US4State FICS.

## SE965 Decode Zone

The table below lists the typical distances for selected barcode densities. The minimum element width (or “symbol density”) is the width in mils of the narrowest element (bar or space) in the symbol.

**Table 22** SE965 Decode Distances

Symbol Density/ Barcode Type	Barcode Content/ Contrast <sup>Note 1</sup>	Typical Working Ranges	
		Near	Far
5.0 mil Code 128	1234 80% MRD	1.2 in 3.05 cm	7.7 in 19.56 cm
5.0 mil Code 39	ABCDEFGH 80% MRD	1.2 in 3.05 cm	12.5 in 31.75 cm
7.5 mil Code 39	ABCDEF 80% MRD	1.1 in 2.79 cm	18.5 in 46.99 cm
10 mil Code 128	1234 80% MRD	1.2 in 3.05 cm Note 3	19.0 in 48.26 cm
13 mil 100% UPC	012345678905 80% MRD	1.6 in 4.06 cm	27.0 in 68.58 cm

**Table 22** SE965 Decode Distances (Continued)

Symbol Density/ Barcode Type	Barcode Content/ Contrast <sup>Note 1</sup>	Typical Working Ranges	
		Near	Far
15 mil Code 128	1234 80% MRD	1.0 in 2.54 cm Note 3	29.5 in 74.93 cm
20 mil Code 39	123 80% MRD	1.4 in 3.56 cm Note 3	52.0 in 132.08 cm
55 mil Code 39	CD 80% MRD	31.4 in 8.64 cm Note 3	100.0 in 254.0 cm
100 mil Code 39	123456 80% MRD	2.0 ft 60.96 cm Note 3	17 ft 518.16 cm
<p><b>NOTE:</b> Contrast is measured as Mean Reflective Difference (MRD) at 650 nm. Working range specifications at temperature = 23°C, pitch=18°, roll=0°, skew=0°, photographic quality, ambient light ~150 ft-c, humidity 45-70% RH. Dependent upon width of barcode. Distances measured from front edge of scan engine chassis.</p>			

## SE4750-SR Decode Zone

The table below lists the typical distances for selected barcode densities. The minimum element width (or “symbol density”) is the width in mils of the narrowest element (bar or space) in the symbol.

**Table 23** SE4750-SR Decode Distances

Symbol Density/ Barcode Type	Typical Working Ranges	
	Near	Far
3.0 mil Code 39	2.8 in 7.11 cm	6.2 in 15.75 cm
5.0 mil Code 128	2.3 in 5.84 cm	8.7 in 22.10 cm
5.0 mil PDF417	3.0 in 7.62 cm	8.1 in 20.57 cm
6.67 mil PDF417	2.2 in 5.89 cm	10.6 in 26.92 cm
10. mil Data Matrix	2.4 in 6.10 cm	10.6 in 26.92 cm
100% UPCA	1.6 in 4.06 cm Note 2	21.6 in 54.86 cm

**Table 23** SE4750-SR Decode Distances (Continued)

Symbol Density/ Barcode Type	Typical Working Ranges	
	Near	Far
15 mil Code 128	2.4 in 6.10 cm Note 2	21.3 in 54.10 cm
20 mil Code 39	1.6 in 4.06 cm Note 2	28.5 in 72.39 cm
<b>NOTE:</b> Photographic quality barcode at 18° pitch angle under 0.1 fcd ambient illumination. Dependent upon width of barcode.		

## SE4850-ER Decode Zone

The table below lists the typical distances for selected barcode densities. The minimum element width (or “symbol density”) is the width in mils of the narrowest element (bar or space) in the symbol.

**Table 24** SE4850-ER Decode Distances

Symbol Density/ Barcode Type	Typical Working Ranges @20 Ft-Cd Minimum	
	Near	Far
10 mil Code 39	3.0 in. * 7.6 cm *	85.0 in. 215.9 cm
13 100% UPC	3.5 in. 8.9 cm	90.0 in. 228.6 cm
15 mil Code 128	6.0 in. * 15.2 cm *	100.0 in. 254.0 cm
20 mil Code 39	4.0 in. * 10.2 cm *	172.0 in. 436.9 cm
40 mil Code 39	6.0 in. * 15.2 cm *	340.0 in. ** 863.6 cm **
55 mil Code 39	7.0* in. * 17.8* cm *	430.0 in. ** 1092.2 cm **
100 mil Code 39 (paper)	20.0* in. * 50.8* cm *	54.0 in. ** 137.2 cm **
100 mil Code 128 (reflective)	11.0 in. * 27.9 cm *	700.0 in. 1778.0 cm
DataMatrix 10	5.0 in. 12.7 cm	45.0 in. 114.3 cm
DataMatrix 55	5.0 in. 12.7 cm	250.0 in. 635.0 cm

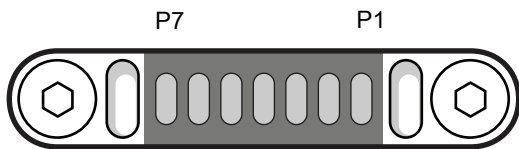


**Table 24** SE4850-ER Decode Distances (Continued)

Symbol Density/ Barcode Type	Typical Working Ranges @20 Ft-Cd Minimum	
	Near	Far
15 mil Code 128 (4 in. wide)	8.0 in. * 20.3 cm *	100.0 in. 254.0 cm
<b>NOTE:</b> * Limited by width of bar code in field of view. ** Range is reduced under low ambient light level.		

## MC33XX Connector Pin-Out

**Figure 159** I/O Connector



**Table 25** I/O Connector Pin-Outs

Pin	Signal Name	Description
1	Ground	Ground pin connected to the Cradle or USB Charge Cable ground.
2	USB ID	Identification signal for USI OTG communication (USB ID) which determines USB mode (host or device).
3	POWER_IN_CON (9V/1.5A or 5V/2Amax)	DC Power supply from the Cradle.
4	USB PWR	Power supply from USB Charging Cable.
5	USB D-	USB OTG data signal negative.
6	USB D+	USB OTG data signal positive.
7	GND	Ground pin connected to the Cradle or USB Charge Cable ground.

## MC33XX Accessory Specifications

The following sections provide technical specifications for the MC33XX accessories.

## 1-Slot USB Charge Cradle with Spare Battery Charger Technical Specifications

**Table 26** 1-Slot USB Charge Cradle with Spare Battery Charger Technical Specifications

Item	Description
Dimensions	Height: 104.5 mm (4.11 in.) Width: 99.1 mm (3.90 in.) Depth: 155.5 mm (6.12 in.)
Weight	376 g (13.26 oz)
Input Voltage	12 VDC
Power Consumption	17 watts
Operating Temperature	0°C to 40°C (32°F to 104°F)
Storage Temperature	-40°C to 70°C (-40°F to 158°F)
Charging Temperature	0°C to 40°C (32°F to 104°F)
Humidity	10% to 95% non-condensing
Drop	75 cm (30 in.) to concrete; 2 drops/side for a total of 12 drops at room temperature.
Electrostatic Discharge (ESD)	+/- 20 kV air +/- 10 kV contact +/- 10 kV indirect discharge

## 5-Slot Charge Only ShareCradle Technical Specifications

**Table 27** 5-Slot Charge Only ShareCradle Technical Specifications

Item	Description
Dimensions	Height: 123.9 mm (4.88 in.) Width: 489.0 mm (19.25 in.) Depth: 142.8 mm (5.622 in.)
Weight	1068 g (37.67 oz)
Input Voltage	12 VDC
Power Consumption	45 watts
Operating Temperature	0°C to 40°C (32°F to 104°F)
Storage Temperature	-40°C to 70°C (-40°F to 158°F)
Charging Temperature	0°C to 40°C (32°F to 104°F)
Humidity	10% to 95% non-condensing

**Table 27** 5-Slot Charge Only ShareCradle Technical Specifications (Continued)

Item	Description
Drop	75 cm (30 in.) to concrete; 2 drops/side for a total of 12 drops at room temperature.
Electrostatic Discharge (ESD)	+/- 20 kV air +/- 10 kV contact +/- 10 kV indirect discharge

## 5-Slot Ethernet ShareCradle Technical Specifications

**Table 28** 5-Slot Ethernet ShareCradle Technical Specifications

Item	Description
Dimensions	Height: 123.9 mm (4.88 in.) Width: 489.0 mm (19.25 in.) Depth: 142.8 mm (5.622 in.)
Weight	2070 g (37.67 oz)
Input Voltage	12 VDC
Power Consumption	47 watts
Operating Temperature	0°C to 40°C (32°F to 104°F)
Storage Temperature	-40°C to 70°C (-40°F to 158°F)
Charging Temperature	0°C to 40°C (32°F to 104°F)
Humidity	10% to 95% non-condensing
Drop	75 cm (30 in.) to concrete; 2 drops/side for a total of 12 drops at room temperature.
Electrostatic Discharge (ESD)	+/- 20 kV air +/- 10 kV contact +/- 10 kV indirect discharge

## 5-Slot Charge ShareCradle with 4-Slot Battery Charger Technical Specifications

**Table 29** 5-Slot Charge ShareCradle with 4-Slot Battery Charger Technical Specifications

Item	Description
Dimensions	Height: 123.9 mm (4.88 in.) Width: 489.0 mm (19.25 in.) Depth: 142.8 mm (5.622 in.)
Weight	2194 g (77.39 oz)

**Table 29** 5-Slot Charge ShareCradle with 4-Slot Battery Charger Technical Specifications (Continued)

Item	Description
Input Voltage	12 VDC
Power Consumption	67 watts
Operating Temperature	0°C to 40°C (32°F to 104°F)
Storage Temperature	-40°C to 70°C (-40°F to 158°F)
Charging Temperature	0°C to 40°C (32°F to 104°F)
Humidity	10% to 95% non-condensing
Drop	75 cm (30 in.) to concrete; 2 drops/side for a total of 12 drops at room temperature.
Electrostatic Discharge (ESD)	+/- 20 kV air +/- 10 kV contact +/- 10 kV indirect discharge

## 5-Slot Ethernet ShareCradle with 4-Slot Battery Charger Technical Specifications

**Table 30** 5-Slot Ethernet ShareCradle with 4-Slot Battery Charger Technical Specifications

Item	Description
Dimensions	Height: 123.9 mm (4.88 in.) Width: 489.0 mm (19.25 in.) Depth: 142.8 mm (5.622 in.)
Weight	2229 g (78.62 oz)
Input Voltage	12 VDC
Power Consumption	69 watts
Operating Temperature	0°C to 40°C (32°F to 104°F)
Storage Temperature	-40°C to 70°C (-40°F to 158°F)
Charging Temperature	0°C to 40°C (32°F to 104°F)
Humidity	10% to 95% non-condensing
Drop	75 cm (30 in.) to concrete; 2 drops/side for a total of 12 drops at room temperature.
Electrostatic Discharge (ESD)	+/- 20 kV air +/- 10 kV contact +/- 10 kV indirect discharge

## 4-Slot Spare Battery Charger Technical Specifications

**Table 31** 4-Slot Spare Battery Charger Technical Specifications

Item	Description
Dimensions	Height: 97.17 mm (3.82 in.) Width: 97.55 mm (3.84 in.) Depth: 143.0 mm (5.63 in.)
Weight	510 g (17.98 oz)
Input Voltage	12 VDC
Power Consumption	30 watts
Operating Temperature	0°C to 40°C (32°F to 104°F)
Storage Temperature	-40°C to 70°C (-40°F to 158°F)
Charging Temperature	0°C to 40°C (32°F to 104°F)
Humidity	10% to 95% non-condensing
Drop	75 cm (30 in.) to concrete; 2 drops/side for a total of 12 drops at room temperature.
Electrostatic Discharge (ESD)	+/- 20 kV air +/- 10 kV contact +/- 10 kV indirect discharge

## 20-Slot Spare Battery Charger Technical Specifications

**Table 32** 20-Slot Spare Battery Charger Technical Specifications

Item	Description
Dimensions	Height: 105.2 mm (4.14 in.) Width: 489.0 mm (19.25 in.) Depth: 142.8 mm (5.62 in.)
Weight	2620 g (92.42 oz)
Input Voltage	12 VDC
Power Consumption	99 watts
Operating Temperature	0°C to 40°C (32°F to 104°F)
Storage Temperature	-40°C to 70°C (-40°F to 158°F)
Charging Temperature	0°C to 40°C (32°F to 104°F)
Humidity	10% to 95% non-condensing

**Table 32** 20-Slot Spare Battery Charger Technical Specifications (Continued)

Item	Description
Drop	75 cm (30 in.) to concrete; 2 drops/side for a total of 12 drops at room temperature.
Electrostatic Discharge (ESD)	+/- 20 kV air +/- 10 kV contact +/- 10 kV indirect discharge

## USB Charge Cable Technical Specifications

**Table 33** USB Charge Cable Technical Specifications

Item	Description
Dimensions	Height: 32.6 mm (1.28 in.) Width: 68.2 mm (2.68 in.) Depth: 1690 mm (66.53 in.)
Weight	120 g (4.23 oz)
Input Voltage	5 VDC
Power Consumption	N/A
Operating Temperature	0°C to 50°C (32°F to 104°F)
Storage Temperature	-40°C to 70°C (-40°F to 158°F)
Charging Temperature	0°C to 40°C (32°F to 104°F)
Humidity	10% to 95% non-condensing
Drop	75 cm (30 in.) to concrete; 2 drops/side for a total of 12 drops at room temperature.
Electrostatic Discharge (ESD)	+/- 20 kV air +/- 10 kV contact +/- 10 kV indirect discharge

# Keypad Remap Strings

---

## Keypad Remap Strings

**Table 34** Remap Key Event/Scancodes

Key Event	Scancode
SOFT_LEFT	105
SOFT_RIGHT	106
HOME	102
BACK	158
CALL	231
ENDCALL	107
0	11
1	2
2	3
3	4
4	5
5	6
6	7
7	8
8	9
9	10
STAR227	227
POUND	228
DPAD_UP	103
DPAD_DOWN	108
DPAD_LEFT	105

**Table 34** Remap Key Event/Scancodes (Continued)

Key Event	Scancode
DPAD_RIGHT	106
DPAD_CENTER	232
VOLUME_UP	115
VOLUME_DOWN	114
CAMERA	212
A	30
B	48
C	46
D	32
E	18
F	33
G	34
H	35
I	23
J	36
K	37
L	38
M	50
N	49
O	24
P	25
Q	16
R	19
S	31
T	20
U	22
V	47
W	17
X	45
Y	21
Z	44



## Keypad Remap Strings

**Table 34** Remap Key Event/Scancodes (Continued)

Key Event	Scancode
COMMA	51
PERIOD	52
ALT_LEFT	56
ALT_RIGHT	100
SHIFT_LEFT	42
SHIFT_RIGHT	54
TAB	15
SPACE	57
EXPLORER	150
ENVELOPE	155
ENTER	28
DEL	111
GRAVE	399
MINUS	12
EQUALS	13
LEFT_BRACKET	26
RIGHT_BRACKET	27
BACKSLASH	43
SEMICOLON	39
APOSTROPHE	40
SLASH	53
AT	215
PLUS	78
MENU	139
SEARCH	217
PAGE_UP	59
PAGE_DOWN	60
PICTSYMBOLS	61
SWITCH_CHARSET	62
BUTTON_A	63
BUTTON_B	64

**Table 34** Remap Key Event/Scancodes (Continued)

Key Event	Scancode
BUTTON_C	65
BUTTON_X	66
BUTTON_Y	67
BUTTON_Z	68
BUTTON_L1	183
BUTTON_R1	184
BUTTON_L2	185
BUTTON_R2	186
BUTTON_THUMBL	187
BUTTON_THUMBR	188
BUTTON_START	189
BUTTON_SELECT	190
BUTTON_MODE	191

# Index

## Numerics

1-slot USB charge cradle . . . . .	34
20-slot spare battery charger . . . . .	55
4-slot spare battery charger . . . . .	53
5-slot charge only cradle . . . . .	38
5-slot cradle with 4-slot battery charger . . . . .	46
5-slot ethernet cradle . . . . .	40
5-slot ethernet cradle with 4-slot battery charger . . . . .	48

## A

ADB USB setup . . . . .	190
advanced data formatting rules . . . . .	127
application details . . . . .	211
approved cleansers . . . . .	215

## B

barcode capture with imager . . . . .	93
barcode capture with laser scanner . . . . .	94
barcode input . . . . .	105
battery safety guidelines . . . . .	214

## C

charge LED indicators . . . . .	24
charge only adapter . . . . .	62
charging battery . . . . .	23
charging spare batteries . . . . .	25
charging temperature . . . . .	25
cleaning instructions . . . . .	214, 215
cleaning the MC33XX . . . . .	215
configuring ADF plug-in . . . . .	127
configuring device to use static IP address . . . . .	154
configuring for a proxy server . . . . .	153
configuring wi-fi networks . . . . .	151
connecting to host computer . . . . .	90
cradle	
connector cleaning . . . . .	216
creating a profile - datawedge . . . . .	98

## D

data capture plus . . . . .	102
datawedge	
decoder params . . . . .	107
decoders . . . . .	106
disabling . . . . .	98
plug-ins . . . . .	96
profile configuration . . . . .	99
profiles . . . . .	95
reader params . . . . .	116
scan params . . . . .	118
UDI params . . . . .	119
UPC EAN params . . . . .	113
datawedge configuration and profile file management	139
datawedge settings . . . . .	136
decode lengths . . . . .	113
decoder params . . . . .	107
development tools . . . . .	189
display	
cleaning . . . . .	216
downloads . . . . .	212

## E

enterprise reset . . . . .	198
exporting a configuration file . . . . .	138
external storage . . . . .	204

## F

factory reset . . . . .	199
feedback . . . . .	18

## G

Google account setup . . . . .	25
--------------------------------	----

## H

hard reset . . . . .	26
harmful ingredients . . . . .	215

hot swap mode ..... 25

## I

importing a configuration file ..... 137  
 install microSD card ..... 19  
 installing applications ..... 191  
 installing battery - MC33XX-G ..... 21  
 installing battery - MC33XX-R/S ..... 22  
 intent output ..... 122  
 internal storage ..... 202  
 IP output ..... 123

## K

keystroke output ..... 120

## L

license manager ..... 179

## M

manually adding wi-fi networks ..... 152  
 MC33XX-G  
   installing battery ..... 21  
 MC33XX-R/S  
   installing battery ..... 22  
 message URL http  
   //www.zebra.com/support .. 164, 195, 198, 199, 217

## P

phone settings ..... 176  
 profiles screen - datawedge ..... 96  
 PTT express configuration ..... 164

## R

reader params ..... 116  
 remapping buttons ..... 161  
 resetting ..... 26  
 resetting device ..... 26  
 rigid holster ..... 69  
 rubber boot - MC33XX-G ..... 65, 66, 68  
 RxLogger ..... 164  
 RxLogger utility ..... 171

## S

scan params ..... 118  
 scanning ..... 93  
 security ..... 177  
 settings  
   phone ..... 176

screen unlock ..... 158  
 wi-fi additional ..... 156  
 wi-fi advanced ..... 155  
 simulscan input ..... 119  
 SmartMU ..... 217  
 soft reset ..... 26  
 storage ..... 201  
 system update ..... 195

## T

troubleshooting ..... 226

## U

UDI params ..... 119  
 uninstalling applications ..... 194  
 un-powered forklift mount ..... 80  
 UPC EAN params ..... 113  
 USB charge cable ..... 58  
 USB debugging ..... 190  
 using ADB ..... 197

## W

WLAN configuration ..... 151

