

CONTENTS OF THE BOX

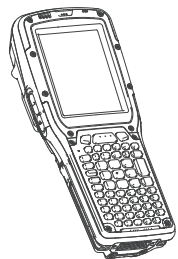

Omnia



This Guide

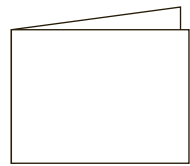

Additional Documentation
(dependent on order)

FEATURES

FRONT, RIGHT AND LEFT

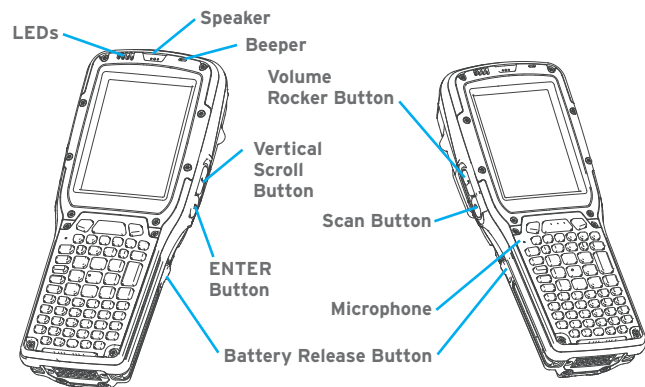

FEATURES AND VARIANTS

EXPANSION BACK COVER

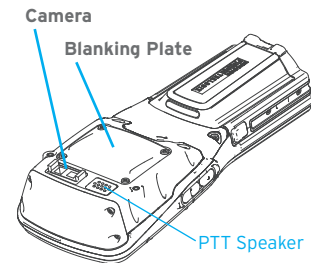

Version without Scanner

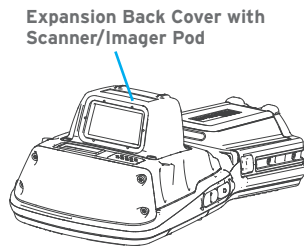

Version with Scanner

Note: GPS radio and end-cap, PTT speaker, and camera are all options available with the Expansion Back Cover.

STANDARD BACK COVER

Standard Back Covers can support a variety of scanners and imagers.

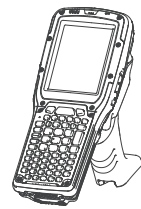
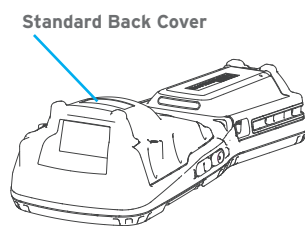

Note: For all variants of both back covers, a pistol grip is available.

BATTERY COMPARTMENT

MICROSD AND SIM CARD SLOTS

To insert a microSD or SIM card:

- > Press the battery release buttons to remove the battery.
- > Use a Phillips screwdriver to remove the SD cover screw.
- > Flip the cover open.

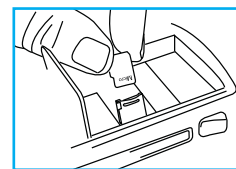
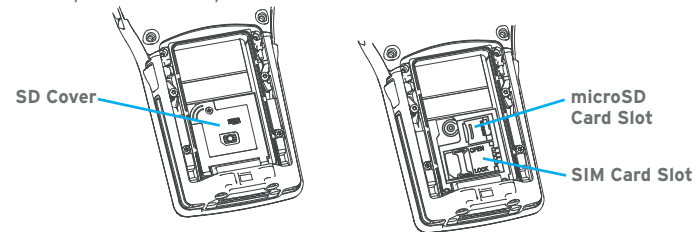

microSD card

- > Slide the microSD door to the left to unlock it. Flip it open.
- > Slide the microSD card onto the guides on the SD card door.
- > Close the microSD door, and slide it to the right to lock it.



SIM card

- > Slide the SIM card metal door latch to the right to unlock it. Flip it open.
- > Slide the SIM card into the guides on the SIM card door.
- > Close the SIM card door, and slide the metal door latch to the left to lock it.

GETTING STARTED

1 Insert the Battery

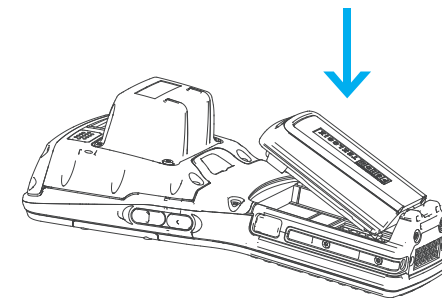

2 Snap the Battery into Place

Press down firmly on both sides of the battery to ensure that it is securely seated in Omnia.

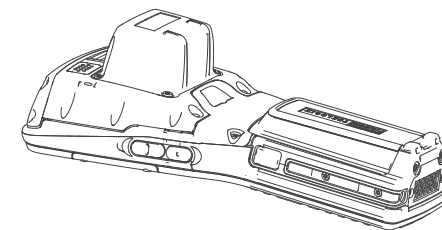

3 Charge the Battery

The power adaptor can be plugged into a snap module attached to Omnii.

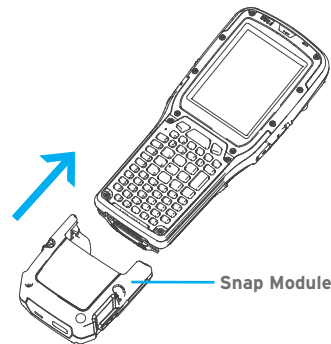

Snap Module

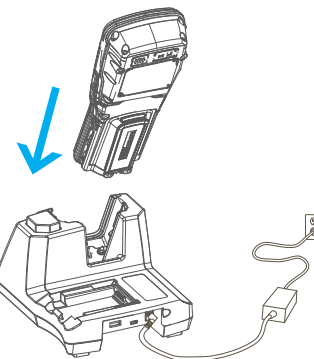

The power adaptor can also be plugged into the desktop docking station.

Note: Use only the universal AC power adaptor and IEC320-C13 power cord approved by Psion for Omnii.



Allow the battery to charge for 3-4 hours.



0 - 40° C
32 - 104° F

Note: Full battery performance is only reached after the first few full charge/discharge cycles.

4 Turn the Unit On

Press and hold down the **ENTER/Power** key for at least one second.

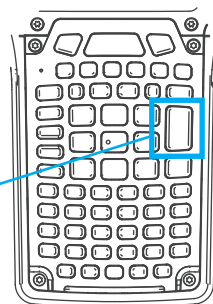

ENTER/Power Key

5 Connect Omnii to the PC

Connect through a docking station or a snap module with a USB port.

6 Install and Configure Data Transfer Software

Use ActiveSync® (Windows® XP® or earlier) or Mobile Device Center® (Windows Vista® or Windows 7®) to establish a connection between Omnii and the PC and synchronize your e-mail, contacts, and so on.

For either ActiveSync or Mobile Device Center, go to the following website:

<http://go.microsoft.com/fwlink/?LinkId=147001>

7 To Turn Omnii Off, Do One of the Following:

- Press the **FN** key followed by the **ENTER/Power** key, or
- In the *Start* menu, choose **Shutdown>Suspend**.

RESETTING THE UNIT



Important: Resetting may result in data loss.

To perform a cold reset:

- Press the **SYM** key, the **FN** key, and the **ENTER/Power** key simultaneously for six seconds.

During a cold reset, running programs are halted and RAM memory is cleared. The contents of flash memory and the registry are preserved. The operating system is reloaded.

To perform a warm reset:

- Press the **FN** key and the **ENTER/Power** key simultaneously for a few seconds.

During a warm reset, running programs are halted. The contents of RAM, flash memory, and the registry are preserved.

© Copyright 2011 by Psion Inc.

Psion, Psion Teklogix, and Omnii are trademarks of Psion Inc. Other product names mentioned in this document are trademarks or registered trademarks of other hardware, software, or service providers and are used herein for identification purposes only.



Psion

Omnii™

HAND-HELD COMPUTER

QUICK START GUIDE



April 7, 2011
PN 8000223.A

ISO 9001 Certified
Quality Management System